



The background features a detailed optical diagram of a telescope. It shows light rays entering from the left, passing through a primary objective lens (1), reflecting off a secondary mirror (2), and exiting through an eyepiece lens (3). A dashed line represents the optical axis. Other components labeled include a secondary mirror (4), a filter (5), and a detector (6). The focal lengths of the objective and eyepiece are denoted as f_1 and f_2 respectively. The number 7 is placed near the secondary mirror.

praktická astronomie

dalekohledy, montáže, velké dalekohledy
aktivní a adaptivní optické systémy
detektory záření
získání pozorovacího času

cvičení
praktická astronomie „pro radost“ I
(včetně kritického komentáře)

dalekohledy

- proč nezkoumáme vesmír jen pouhýma očima?

- dalekohledy soustředí záření z větší plochy
- umožní lepší úhlové rozlišení
- nejen světlo
- dávají možnost detektorem získat trvalý záznam

- dnes je přesnější mluvit o „pozorovacích systémech“, které jsou složeny z několika částí:

- *dalekohled* (reflektor, refraktor, katadioptrický d.)
- *měřicí zařízení* (fotoaparát, kamera, spektrograf ...)
- *detektor* (oko, fot. emulze, fotonásobič, CCD)

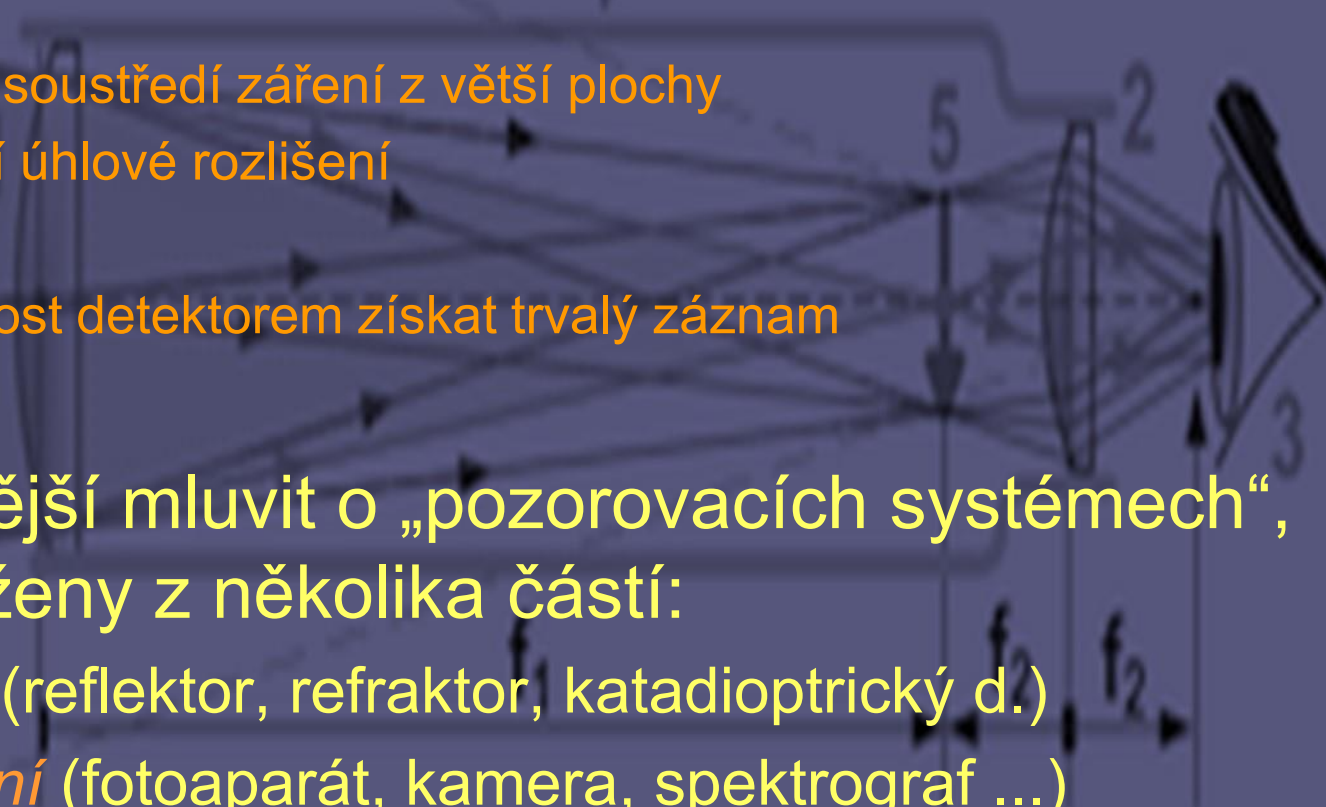

dalekohledy

- dalekohled se skládá z hlavního optického prvku – tzv. *objektivu*, který vytváří obraz v *ohniskové rovině (ohnisková vzdálenost)*
- obraz si lze (mimo jiné) prohlížet jiným optickým prvkem – *okulárem* (lupa)
- obecně pak jde vždy o:
 - zobrazování
 - fotometrie – měření vlastností záření



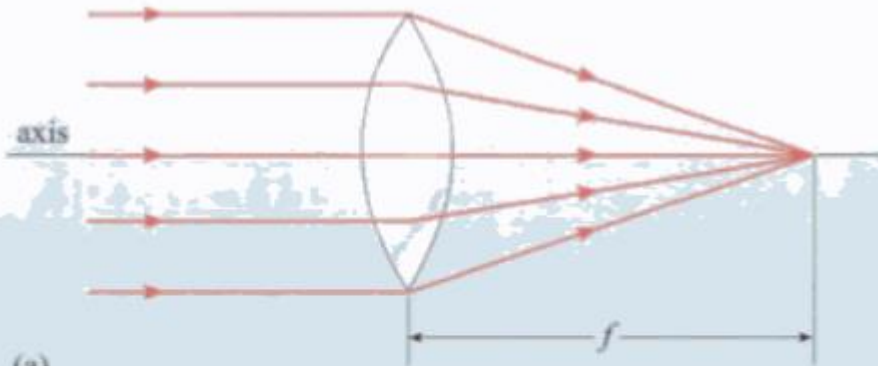

(a)

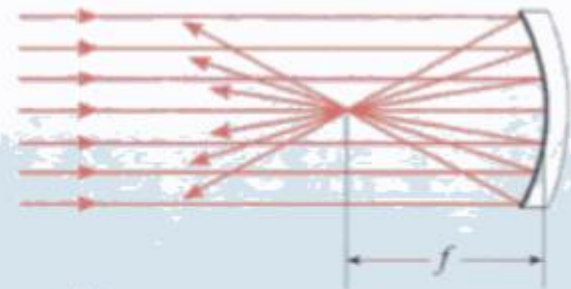

(b)

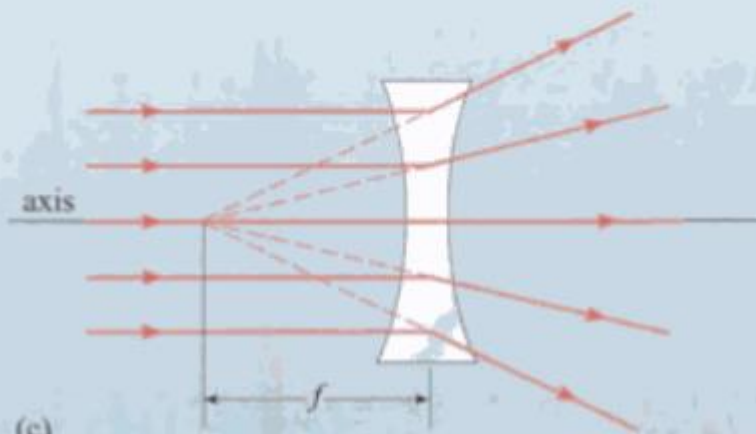

(c)

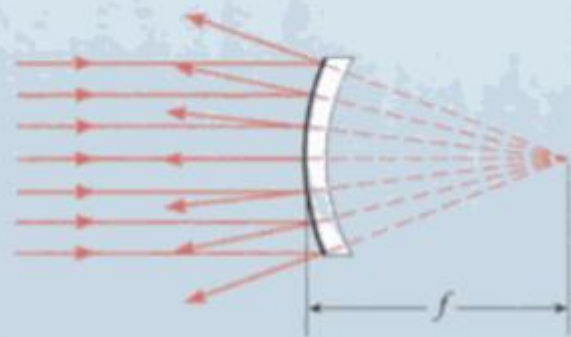

(d)

dalekohled

- charakteristiky

- průměr hlavního objektivu (vstupní pupily) D
- ohnisková vzdálenost f
- světelnost = f/D
- zvětšení f_{obj}/f_{okul}
- velikost zorného pole



dalekohledy

- mezní hvězdná velikost

$$\frac{J_D}{J_O} = \frac{D^2}{d^2}$$

$$\frac{F_D}{F_O} = \frac{D^2}{d^2}$$

$$m_D - m_O = -2,5 \log_{10} (F_D / F_O) = -5 \log_{10} (D / d)$$

$$m_{\text{lim}} = 6 + 5 \log_{10} (D / d)$$

$$m_{\text{lim}} \cong 16,5 + 5 \log_{10} D$$

$$m_{\text{lim}} \cong 16 + 5 \log_{10} D$$

- průměry jsou v metrech, předp. $d=0,008$ m a ztrátu světla v opt. soustavě cca 0,5 mag

dalekohledy

- úhlové rozlišení
ani bodový zdroj se nezobrazí jako bod, ale jako kruhový difrakční obraz – tzv. *Airyho disk*
- tak je dáno maximální úhlové rozlišení dalekohledu (*difrakční limit*)
- SW lze tuto hranici překonat
- seeing bývá větší

$$\alpha = \frac{1,22\lambda}{D}$$

dalekohled

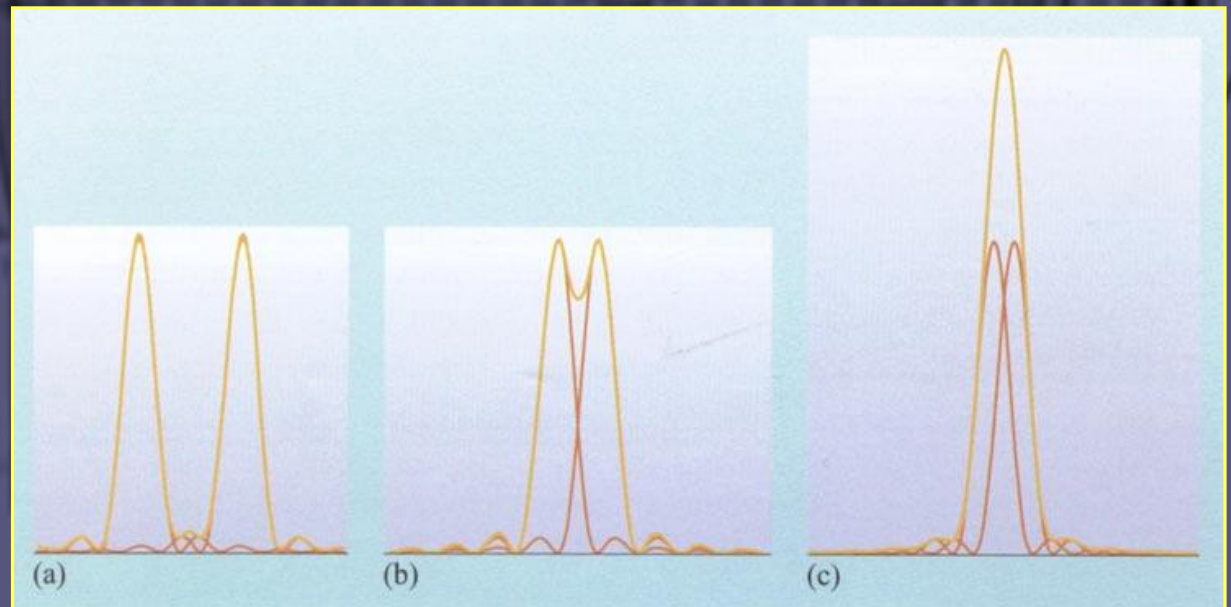
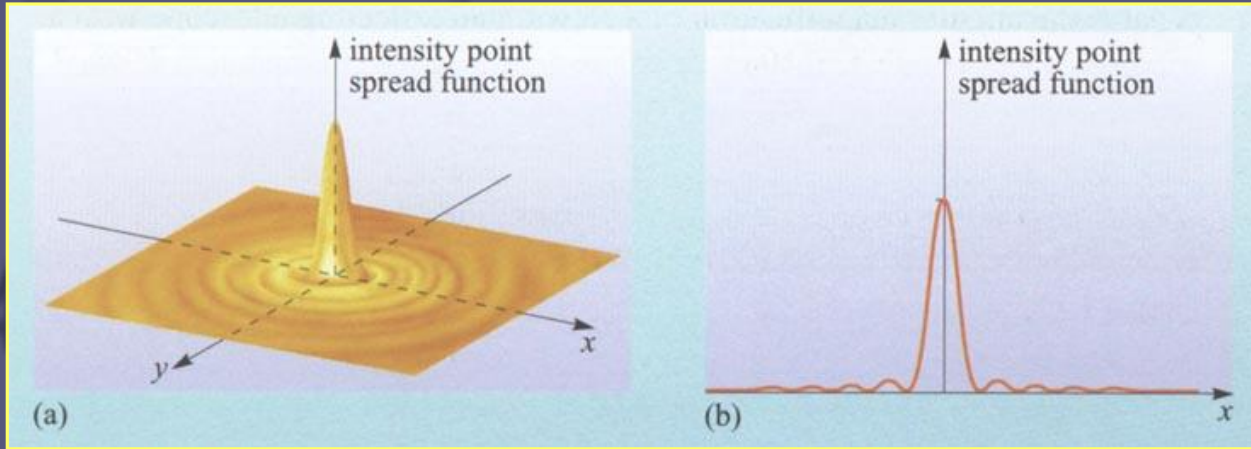

dalekohledy

- refraktor

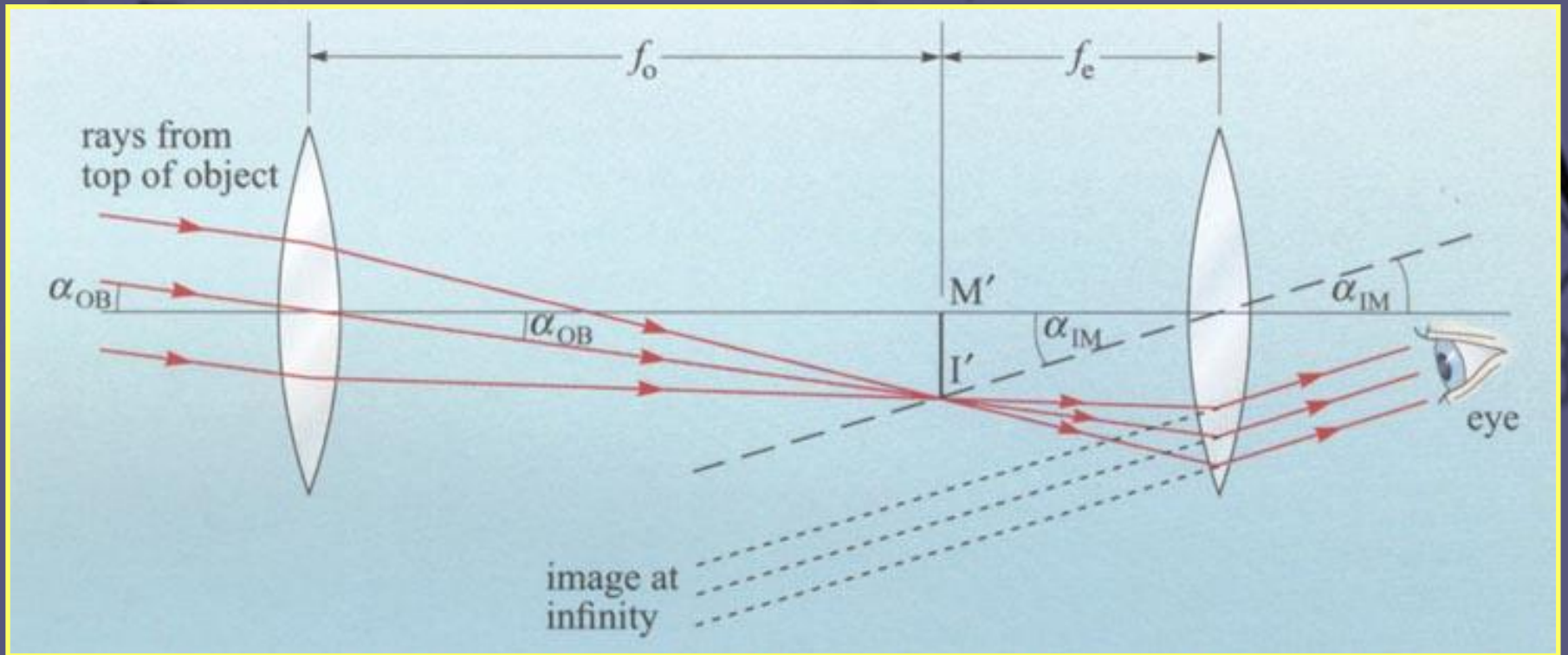

dalekohledy

- reflektor

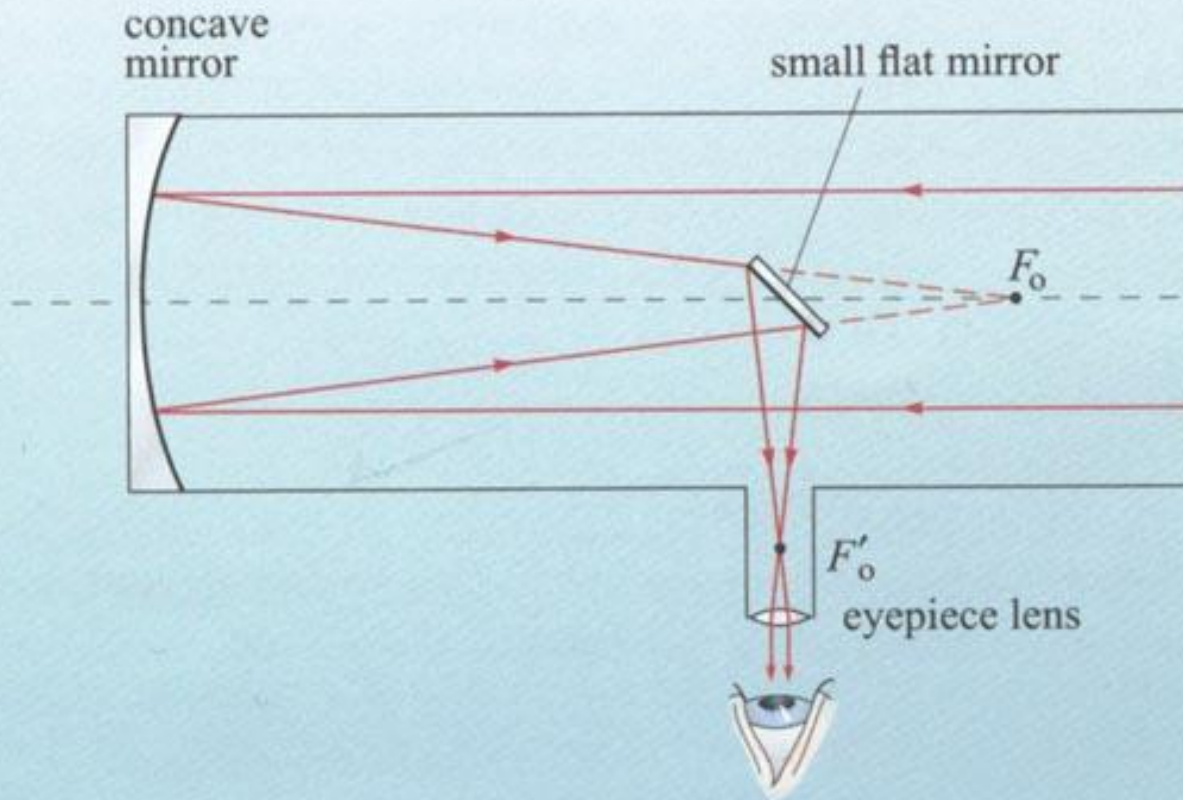

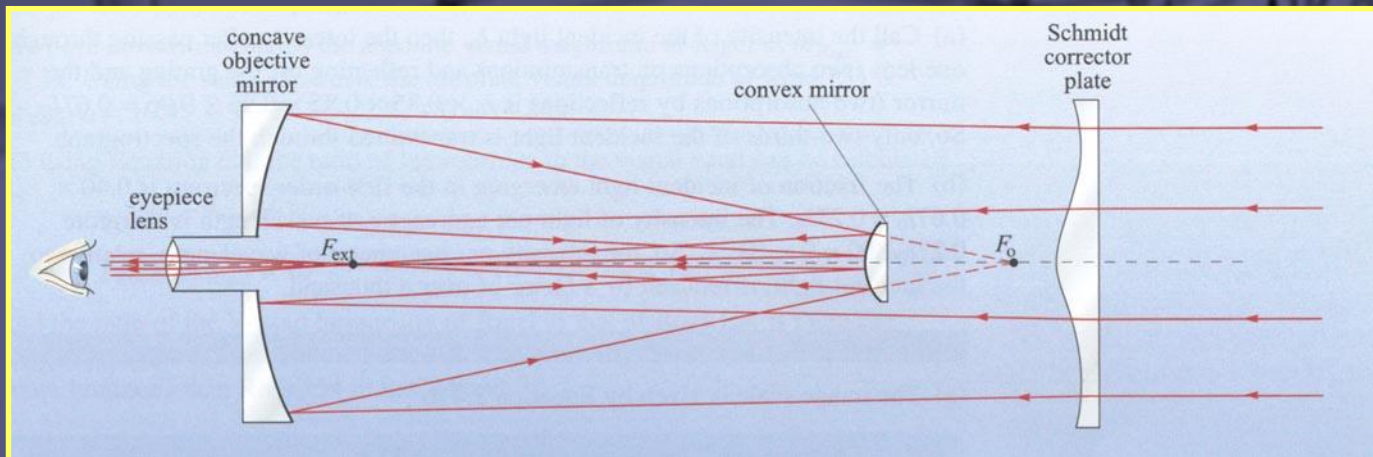
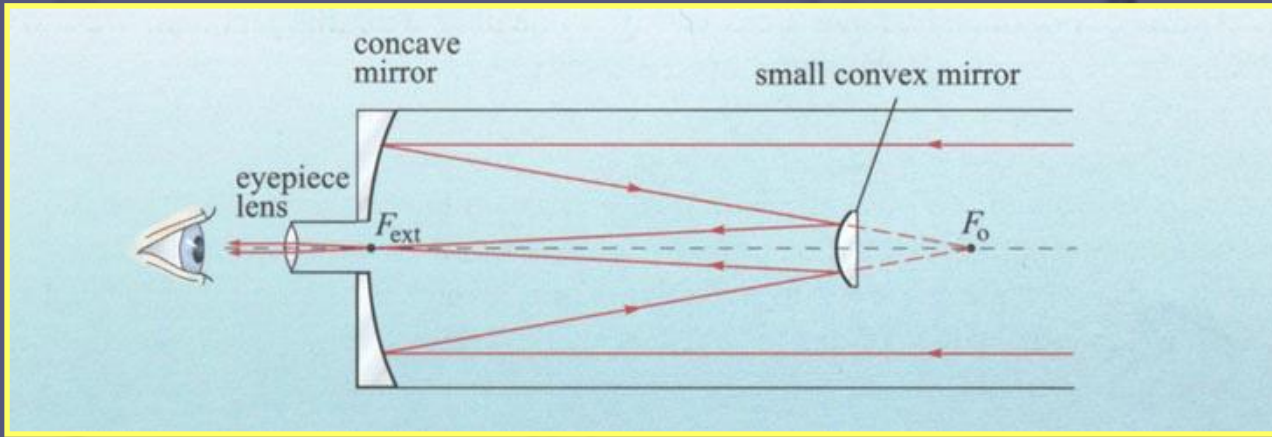
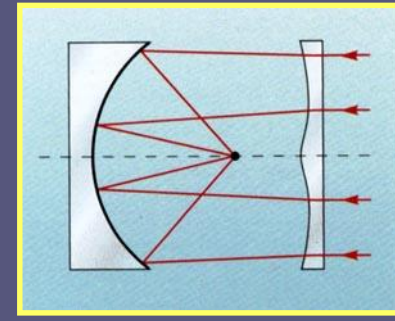
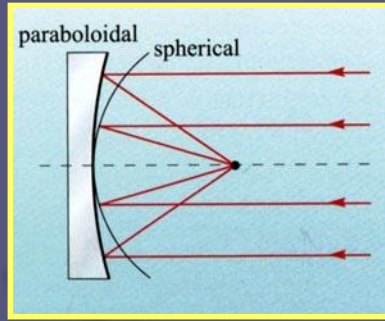
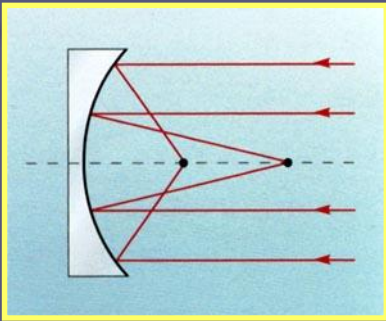

další varianty

vady optiky

- velmi dobře zpracovaný text o vadách optiky je zde
- [kvalita optických přístrojů](#)

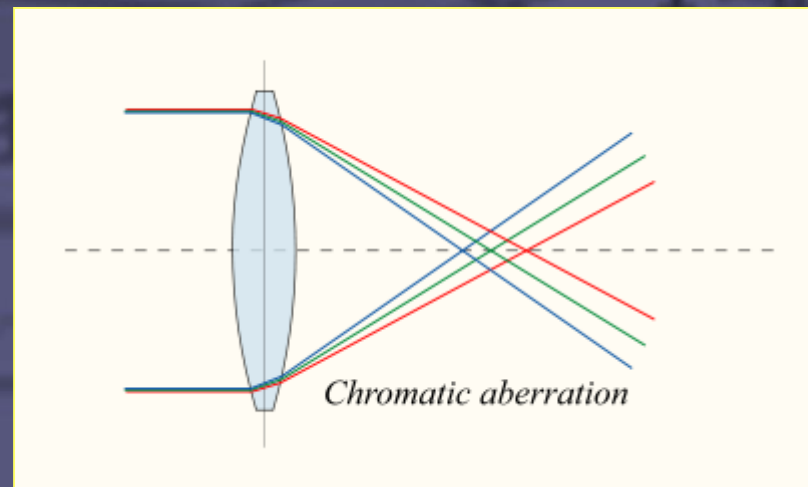

montáže

- **azimutální montáž**
 - stativ s vidlicí
 - Dobsonova montáž
- azimutální montáže u velkých dalekohledů převažují
- **paralaktická montáž**
 - německá montáž, hmotnost tubusu je kompenzována protizávažím
 - vidlicová paralaktická montáž, tubus dalekohledu je držen v těžišti jednou či dvěma vidlicemi



montáže

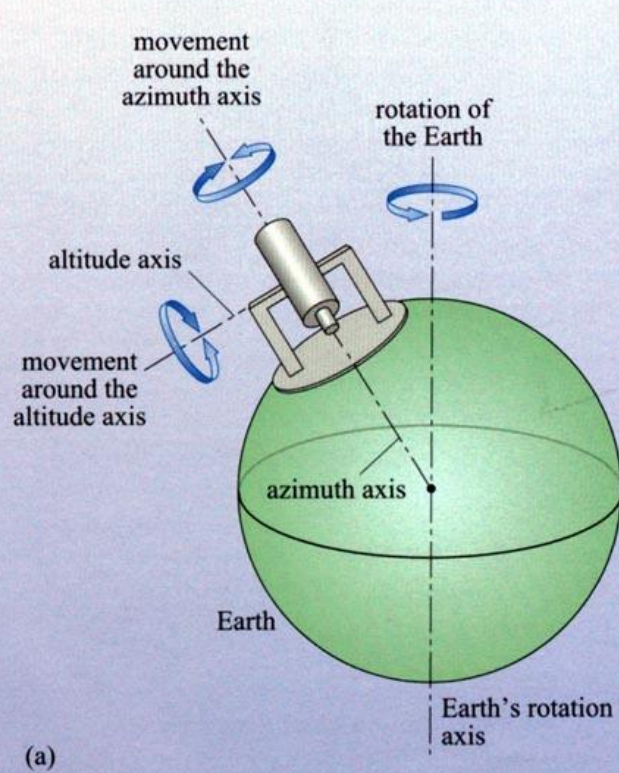

(a)

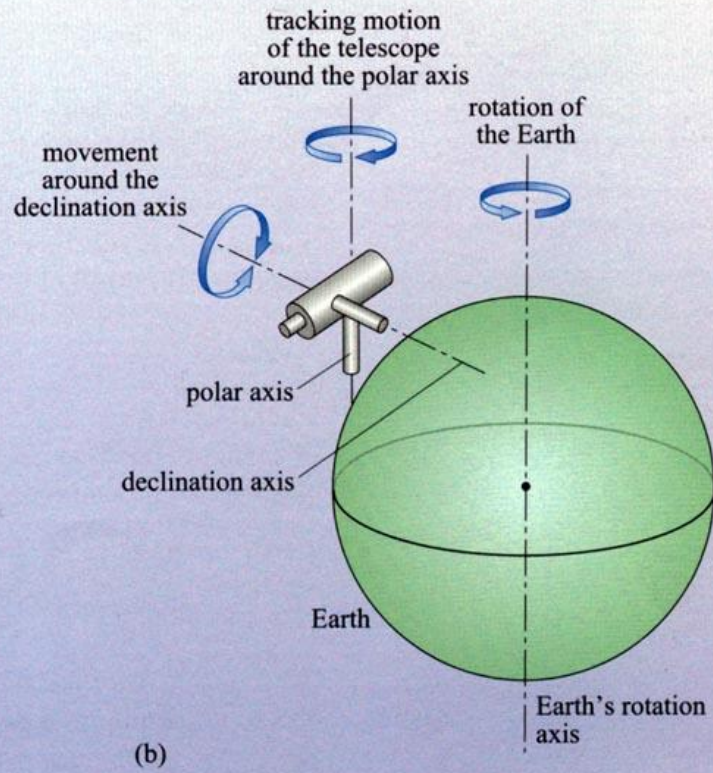

(b)

historická mezihra

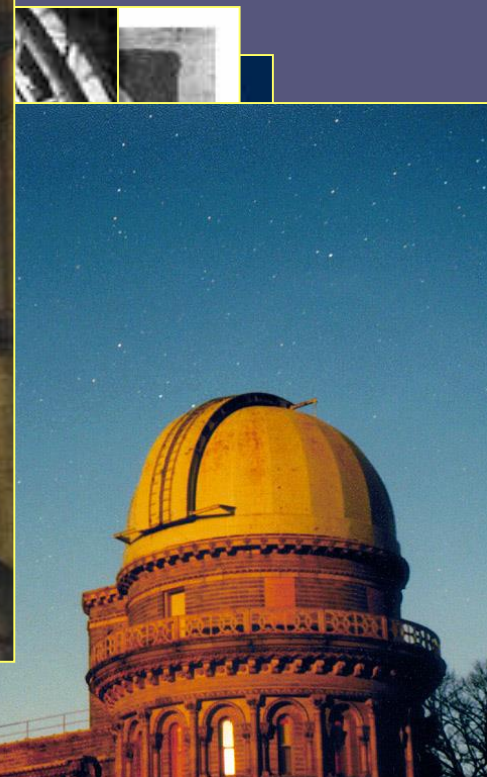
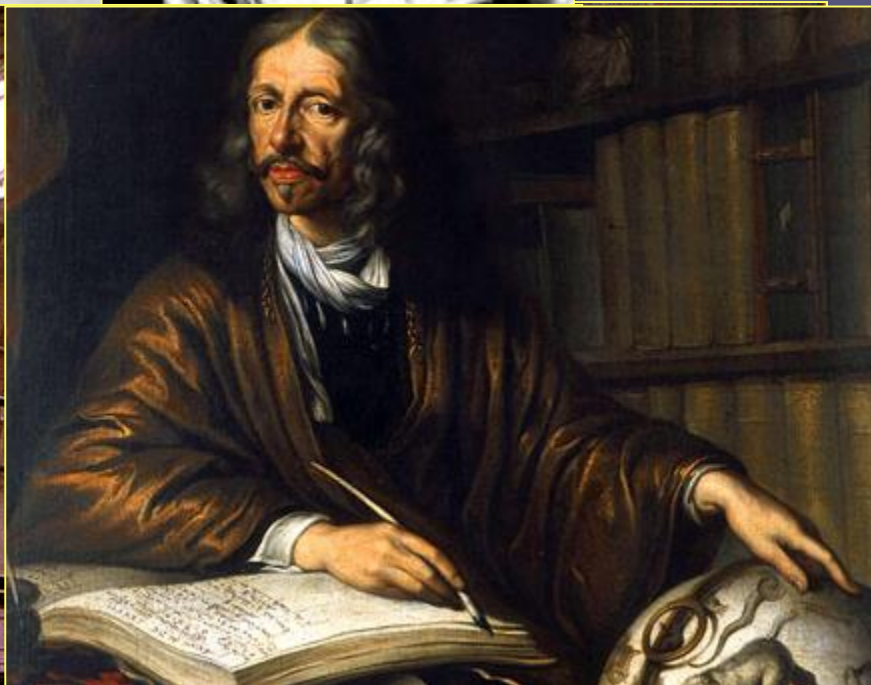

historická mezihra

- refraktory dosáhly limitujícího rozměru
- rozvoj reflektorů na bázi monolitického skleněného primárního zrcadla
- Mt. Palomar, Haleův reflektor
- Zelenčukskaja, BTA
- následuje technologický zlom, použití tenkých nebo segmentovaných primárních zrcadel
- průměr primárního zrcadla není vše, rozhoduje detektor

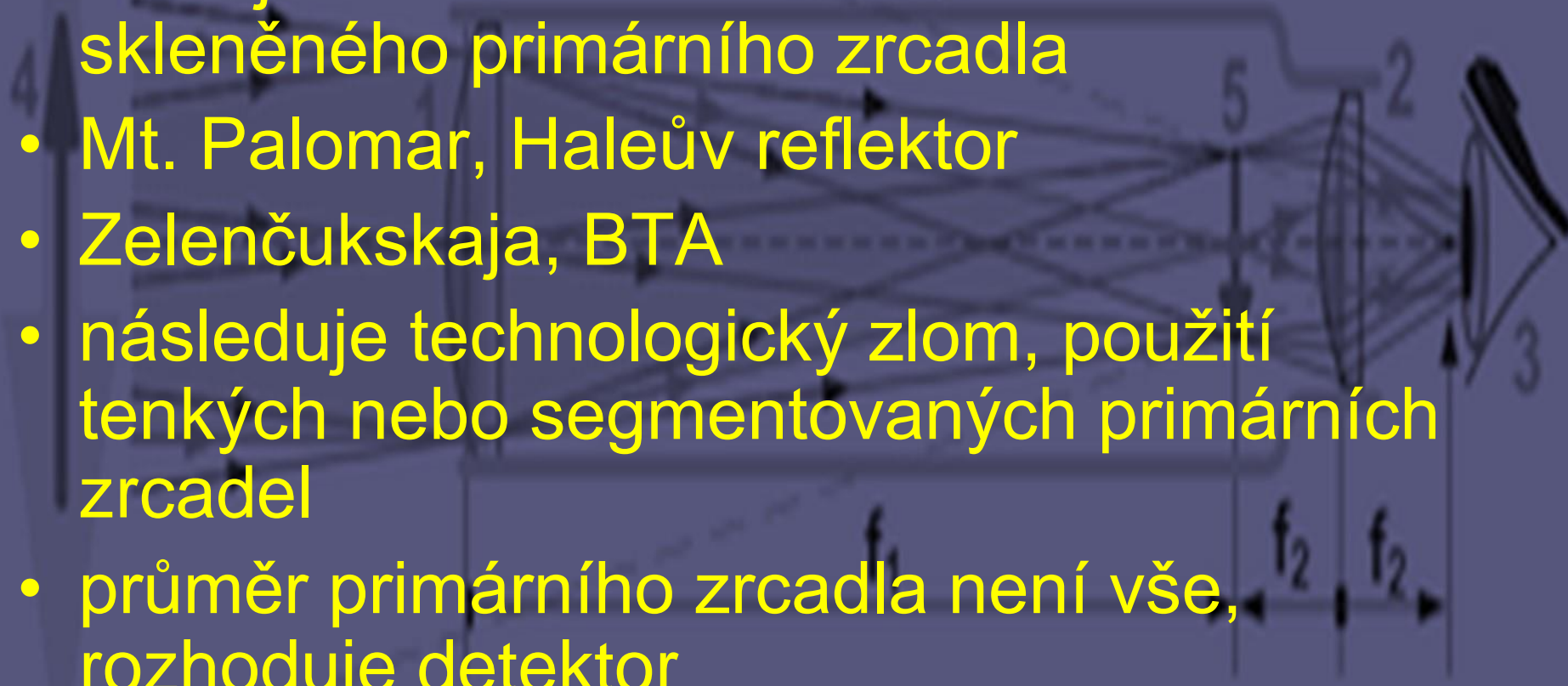



2.5-m Hooker
Mount Wilson, CA • 1917



5.1-m Hale
Palomar Mountain, CA • 1948

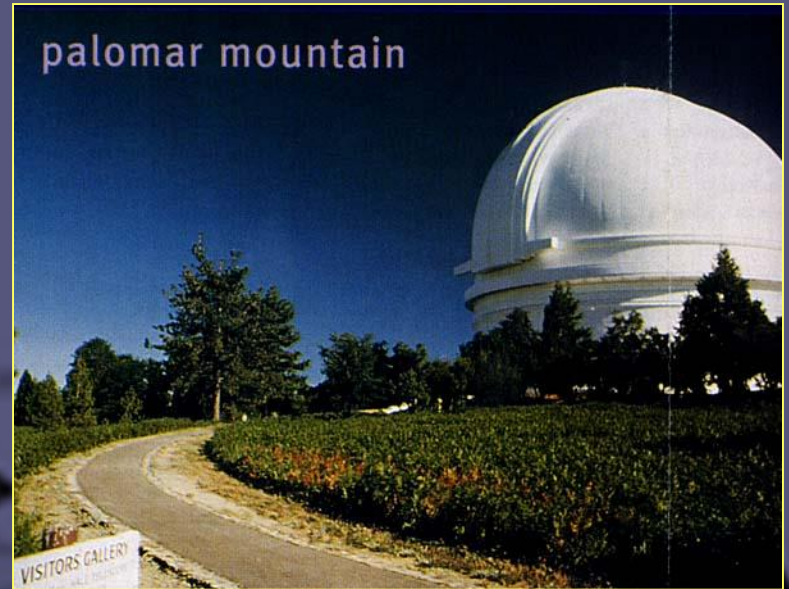

palomar mountain



3.8-m Mayall
Kitt Peak, AZ • 1973



3.9-m Anglo-Australian Telescope
Siding Spring Mountain,
Australia • 1974

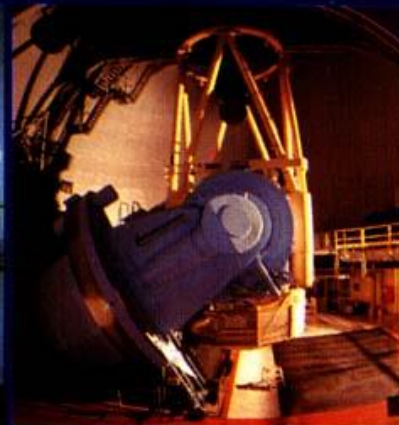

3.6-m ESO
La Silla, Chile • 1977



3.6-m Canada-France-Hawaii Telescope
Mauna Kea, HI • 1979

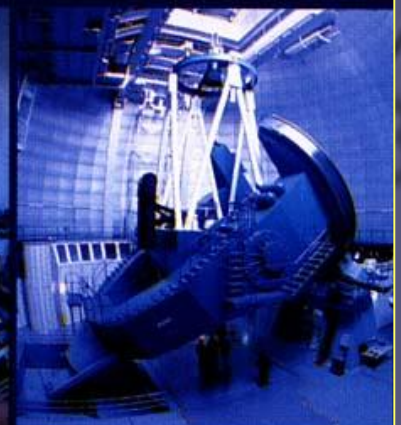

3.5-m Calar Alto
Calar Alto, Spain • 1984

historická mezihra

- observatoře na oběžné dráze, HST
- průměr ani detektor nejsou vše, rozhoduje adaptivní optika
- pozemské observatoře opět mohou konkurovat těm kosmickým
- vývoj pokračuje trendem, že na každý astronomický problém je potřeba zvolit ten správný pozorovací prostředek



NASA

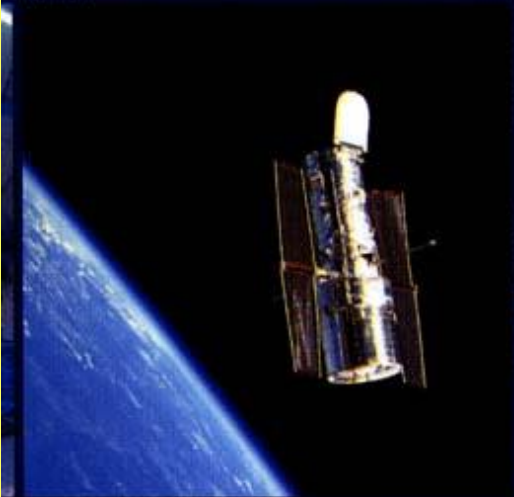

2.4-m Hubble Space Telescope
Earth orbit • 1990



9.8-m
Mauna



orth)
1999



Very Large Telescope
Cerro Paranal, Chile • 2001

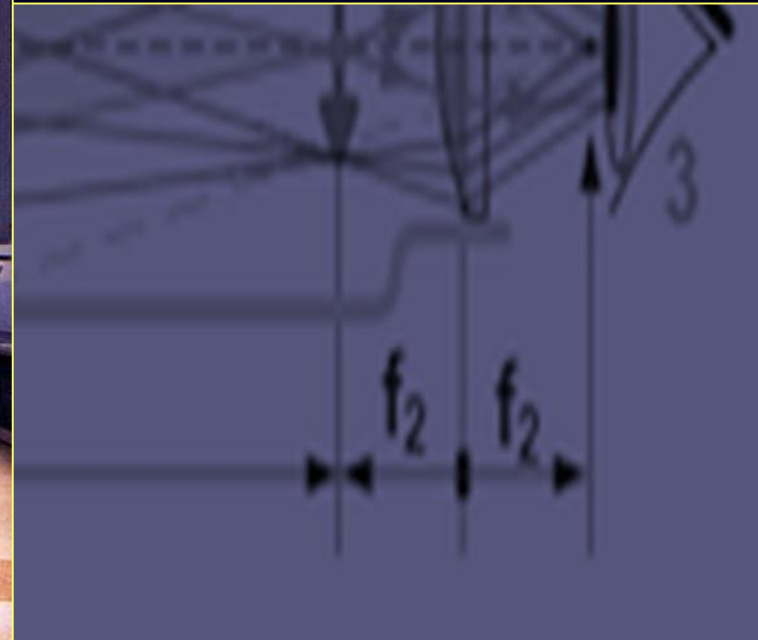

Kolik očí máte pod tubusem, pane?

- netradiční jednotka nám může nahradit informaci o průměru dalekohledu
- Galileo 25 očí
- Yerkes 16 kiloočí
- lord Rosse 52 kiloočí
- Mt. Wilson 100 kiloočí
- Mt. Palomar 400 kiloočí
- HST 90 kiloočí

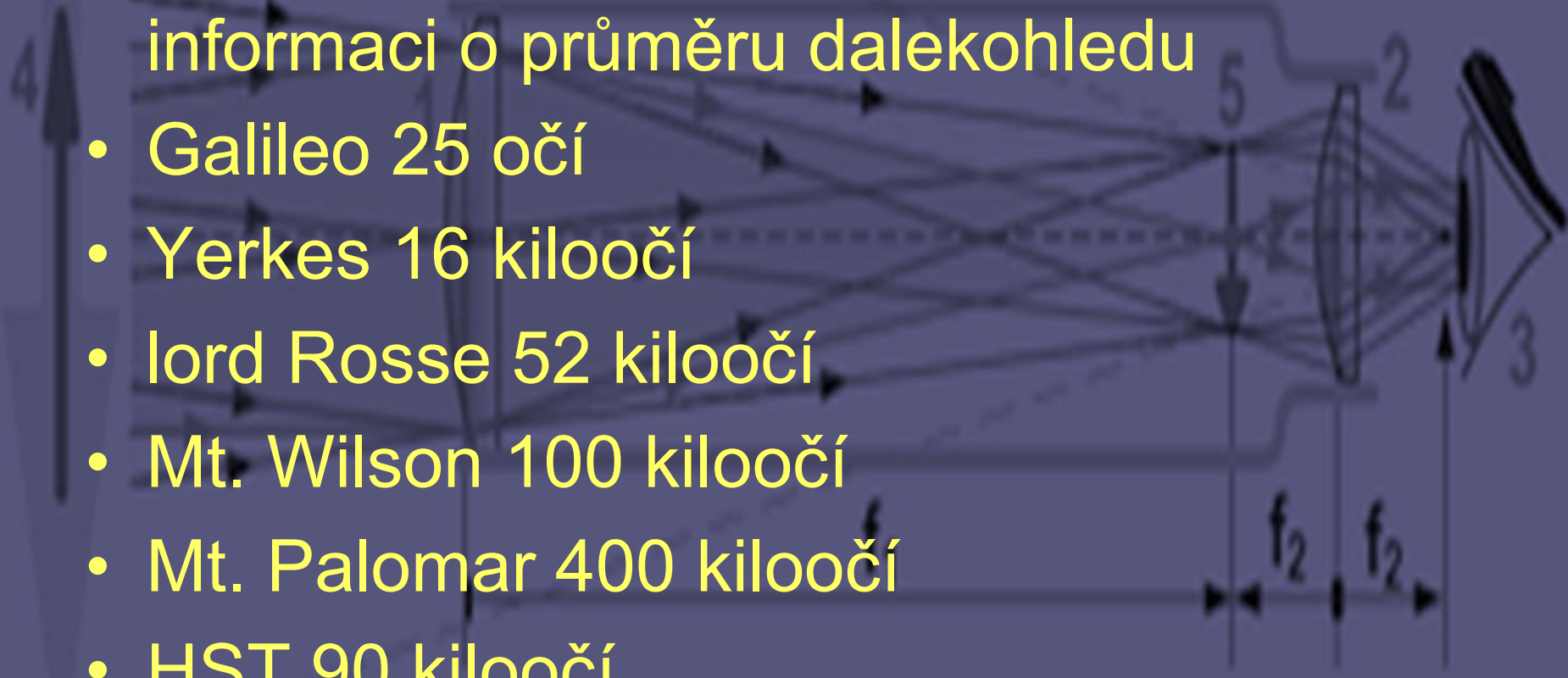

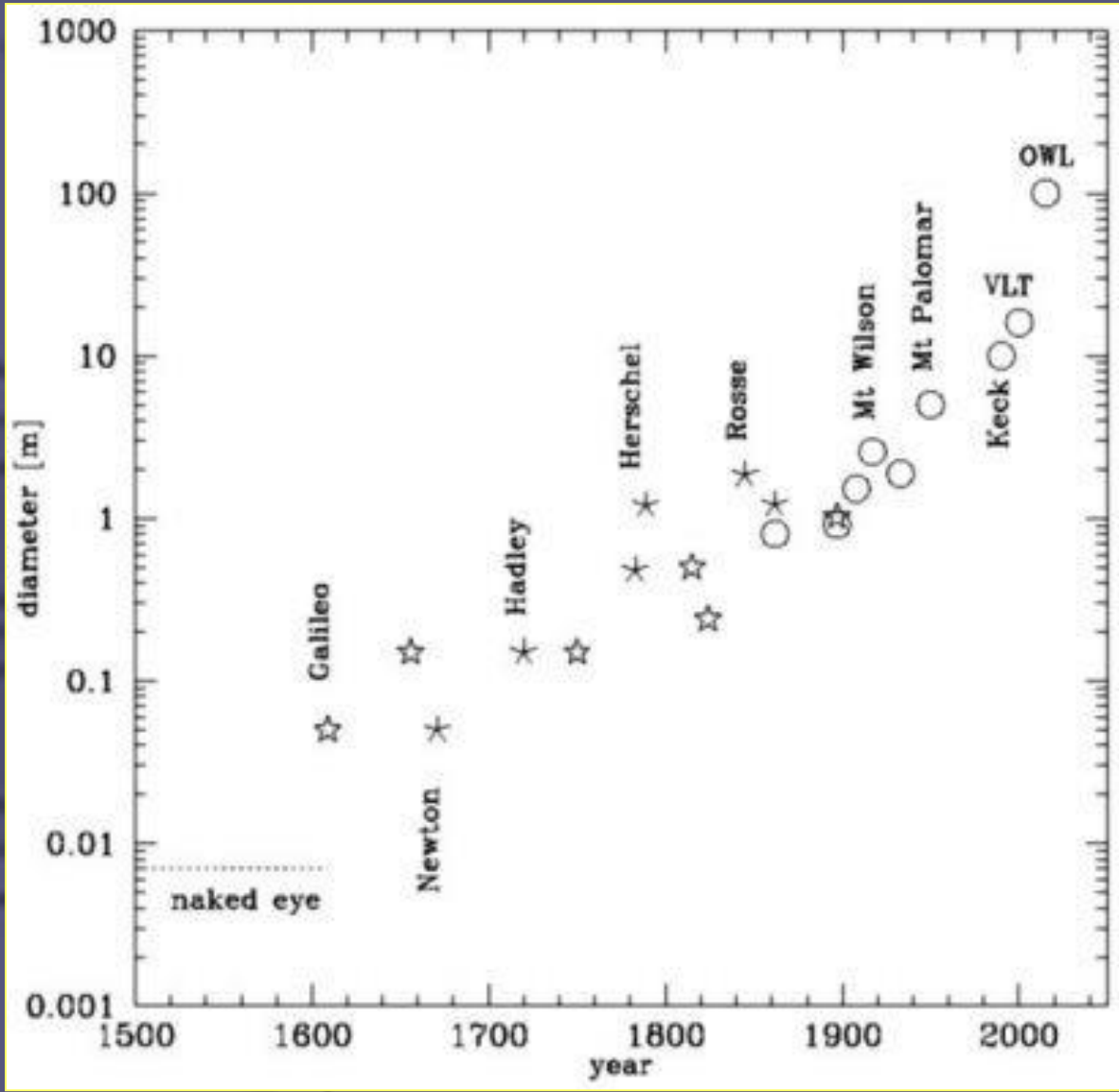

top 10

- Very Large Telescope
- 4x 8,2 m - 4,2 megaočí
- ESO, Cerro Paranal
- pracují od r. 2001, nyní i jako interferometr
- optika R-Ch, altazimut
- <https://www.eso.org/public/czechrepublic/teles-instr/paranal-observatory/vlt/>



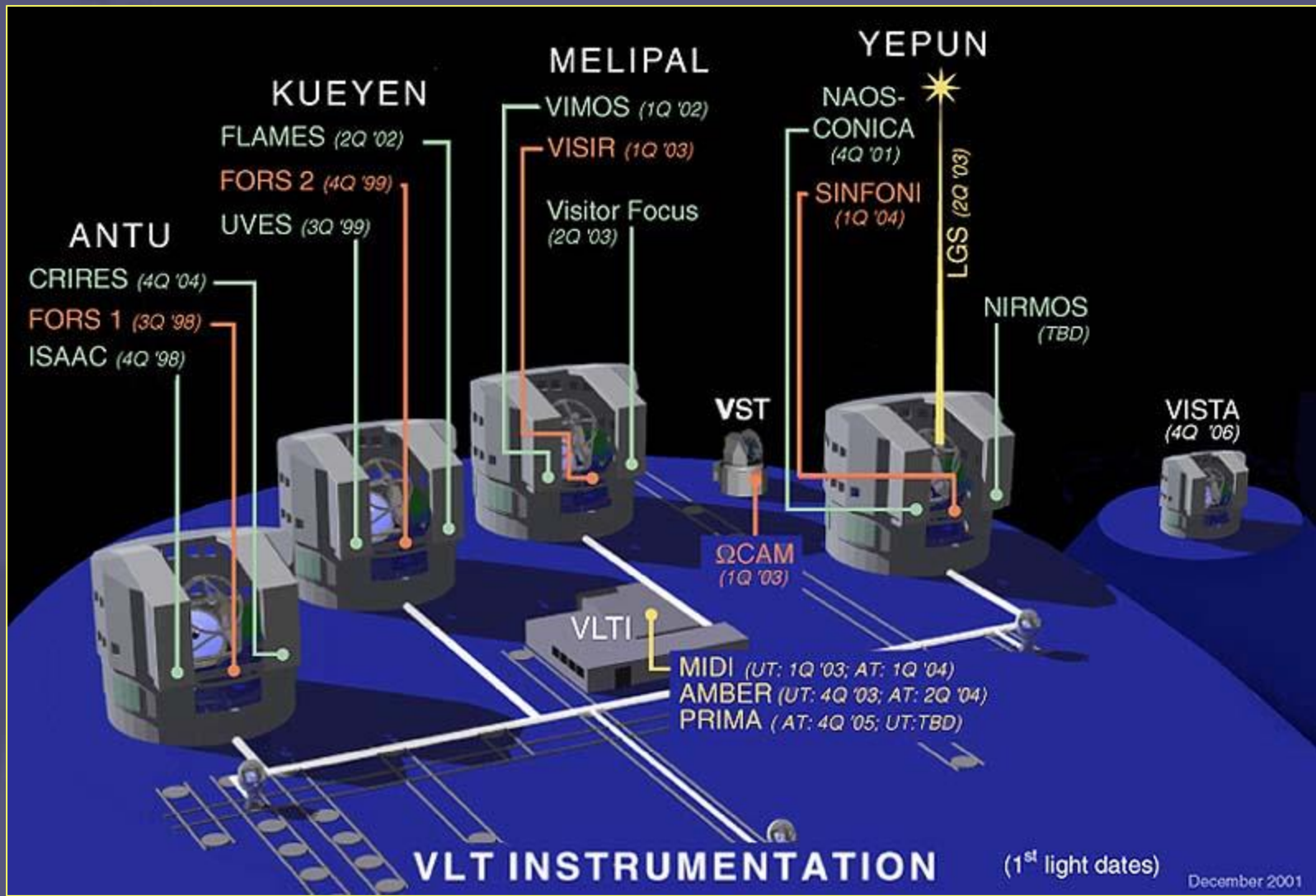

top 10

- Keckovy dalekohledy
- 2x 9,82 m - 3,06 megaočí
- Caltech, Mauna Kea
- 1991, 1996
- optika R-Ch, 36 hexagon. segmentů, altazimut, 300 t
- <https://keckobservatory.org/>



top 10

- Large Binocular Telescope
- 2 x 8,4 m - 2,2 megaočí
- 12 partnerů USA, Itálie, SRN, Mt. Graham
- dokončení r. 2008
- optika Cass, altazimut, 350 t
- <https://www.lbto.org/>



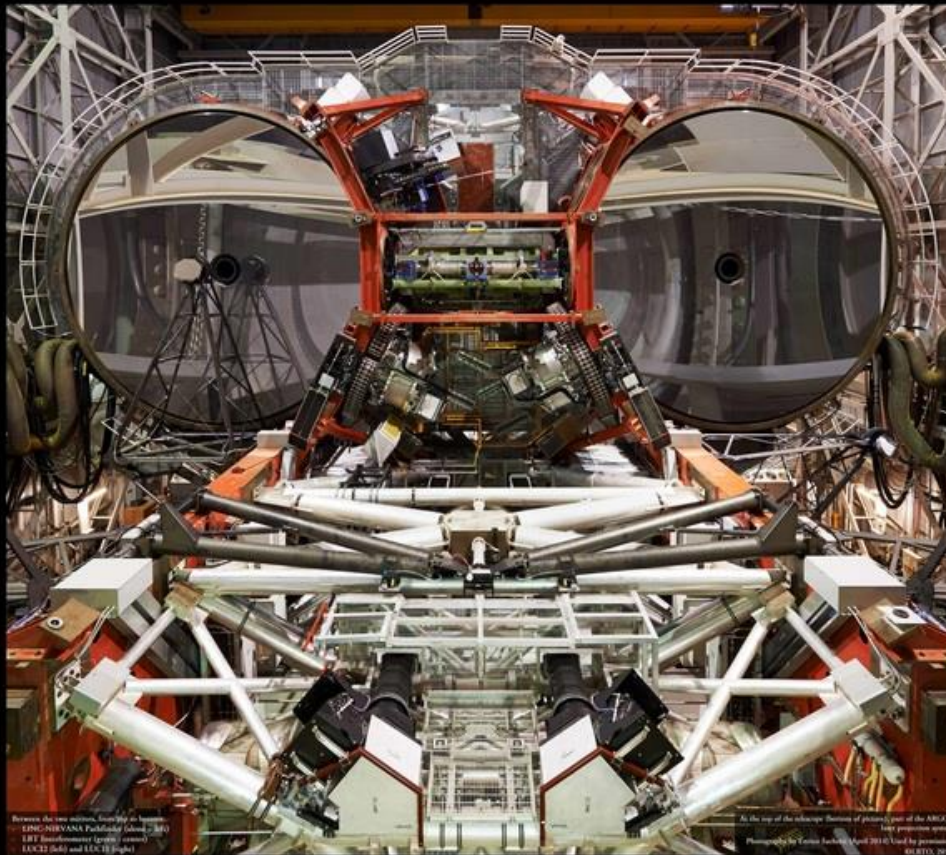

Between the two mirrors, from left to right:
 LINC-NIRVANA Fieldfinder (white - left)
 LBT Instruments (grey - center)
 LUCIF (left) and LUCY (right)

At the top of the telescope, bottom of photo, part of the ABC205 laser projection system
 Photograph by Corbin Jacobus, April 2010. Used by permission
 © LBT, 2011

LBT Observatory 2014



MOOSIE (left) and MIMOS2 (right) at the Digital Composite Focus of each main mirror. Photograph by Rick Foye



top 10

- Gran Telescopio Canarias
- 10,4 m - 1,7 megaočí
- Španělsko a partneři, La Palma, Kanárské ostrovy
- dokončení r. 2006
- optika R-Ch, altazimut, obdoba Keckova dal., 36 hexagonálních segmentů o 1,9 m
- <http://www.gtc.iac.es/>

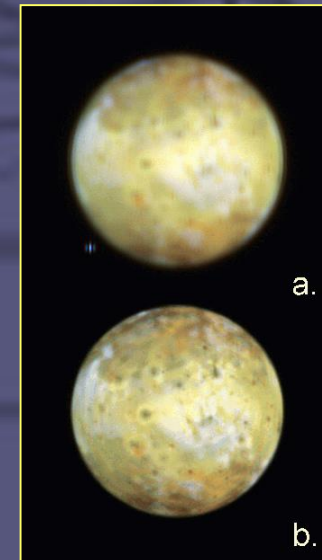

top 10

- Hobby - Eberly Telescope
- 9,1 m - 1,3 megaočí
- 5 univerzit USA, SRN, Mount Fowlkes, Texas
- dokončení r. 1997
- sférický tvar, pouze azimut, výška je fixní 55 st., 100 t
- <https://mcdonaldobservatory.org/research/telescopes/HET>



top 10

- Southern African Large Telescope
- cca 10 m - 1,5 megaočí
- dvojče HET, Sutherland, JAR
- dokončení r. 2005
- sférický tvar, pouze azimut, výška je fixní 55 st., 100 t
- <https://www.salt.ac.za/>



top 10

- Subaru
- 8,2 m - 1,05 megaočí
- Japonsko, Mauna Kea
- dokončení r. 1999
- optika R-Ch, altazimut, hmotnost 500 tun, budova rotuje s dalekohledem
- https://en.wikipedia.org/wiki/Subaru_Telescope



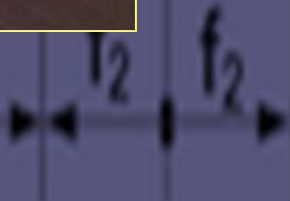
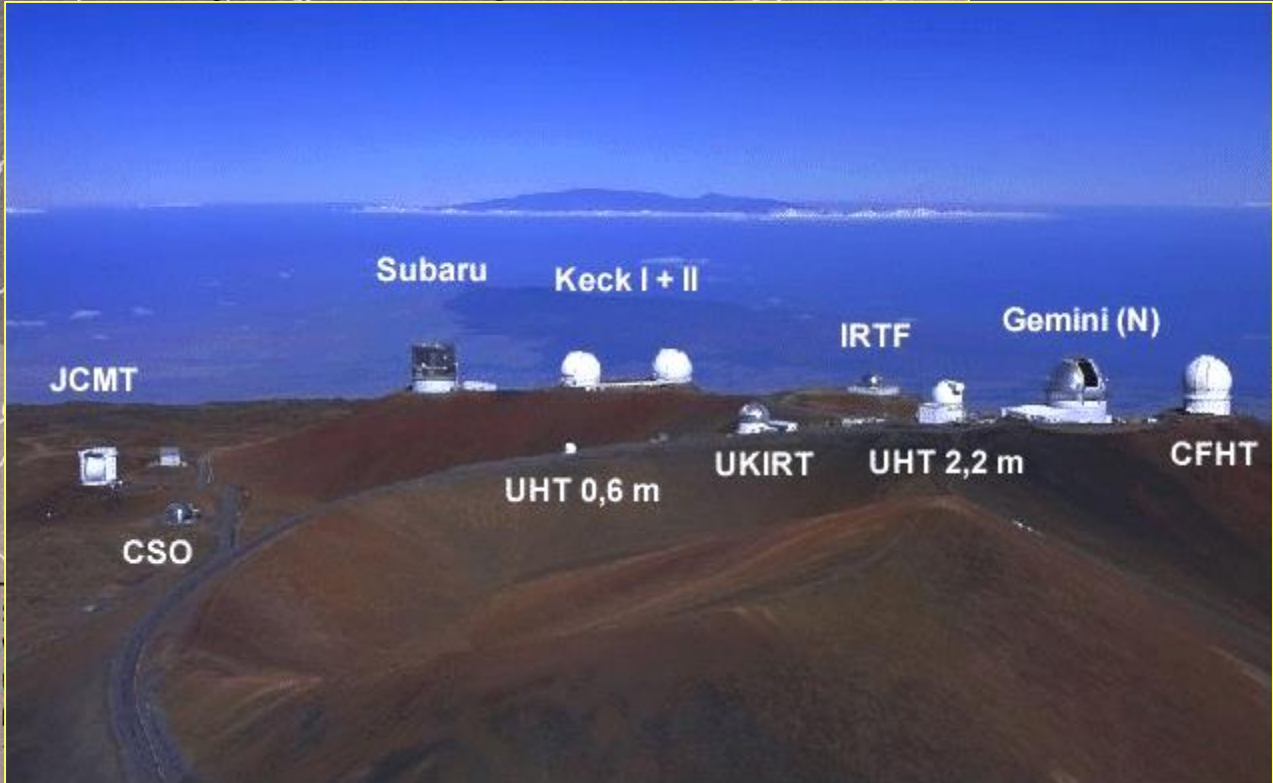
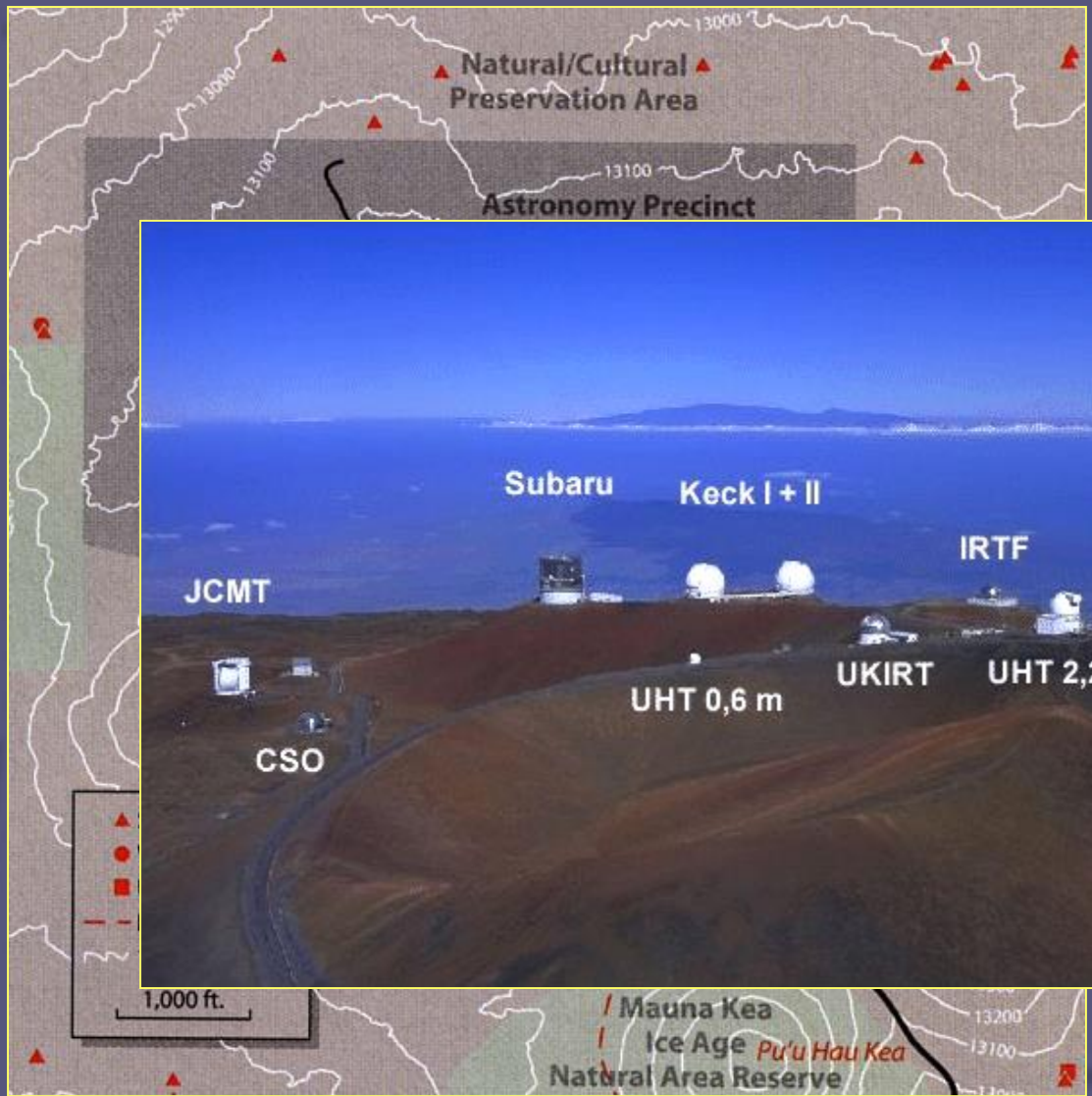

top 10

- Gemini (sever)
- 8,1 m - 1,02 megaočí
- Mauna Kea
- dokončení r. 2000
- optika R-Ch, altazimut, hmotnost 342 t
- <http://www.gemini.edu/>

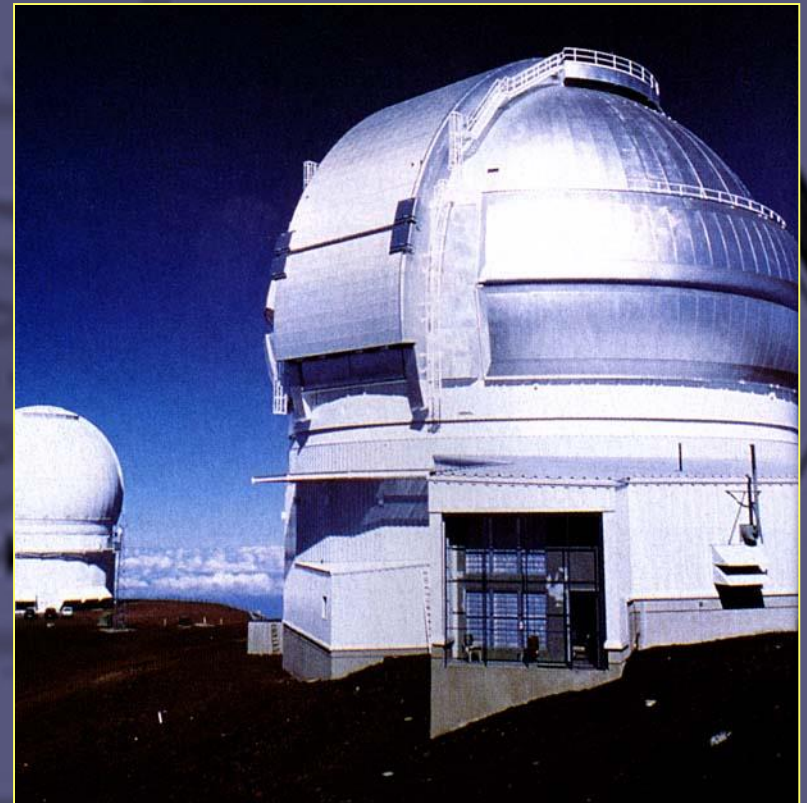

top 10

- Gemini (jih)
- 8,1 m - 1,02 megaočí
- USA, GB, Kanada, Chile, Austrálie, Argentina, Brazílie, spravuje AURA, Cerro Pachón
- dokončení r. 2001
- optika R-Ch, altazimut, hmotnost 342 t
- <http://www.gemini.edu/>

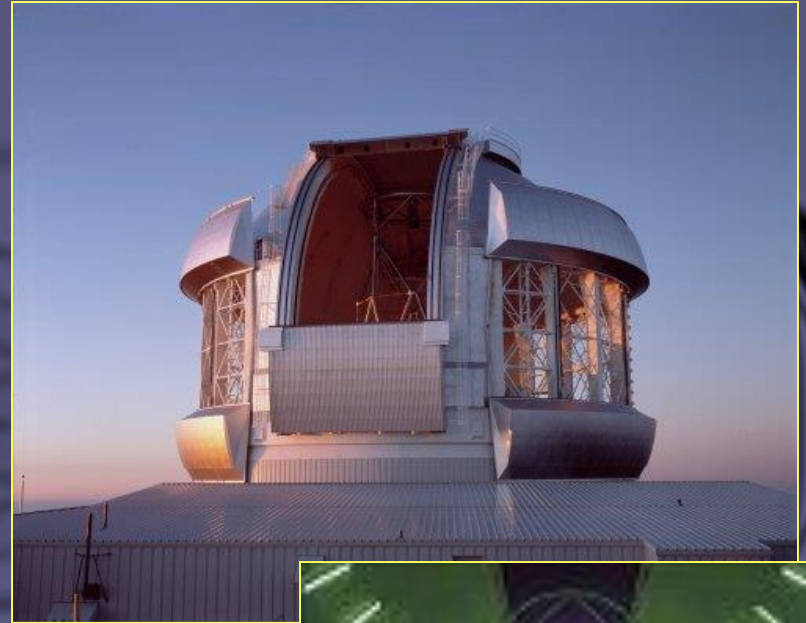

top 10

- Magellan
- 2 x 6,5 m - 1,3 megaočí
- USA, Las Campanas, Chile
- dokončení r. 2002
- optika Cass, altazimut, hmotnost 130 t
- <https://obs.carnegiescience.edu/Magellan>



velké dalekohledy aktuálně

https://en.wikipedia.org/wiki/List_of_largest_optical_reflecting_telescopes



Great Paris Exhibition Telescope

(lens at the same scale)
Paris, France (1900)



Yerkes Observatory

(40" refractor lens at the same scale)
Williams Bay, Wisconsin (1893)



Hooker (100")
Mt Wilson, California (1917)



Hale (200")
Mt Palomar, California (1948)



Multi Mirror Telescope
Mount Hopkins, Arizona (1979-1998)



BTA-6 (Large Altazimuth Telescope)
Zelenchuksky, Russia (1975)



Large Zenith Telescope
British Columbia, Canada (2003)



Gala
Earth-Sun L2 point (2014)



James Webb Space Telescope
Earth-Sun L2 point (planned 2018)



Tennis court at the same scale

Large Sky Area Multi-Object Fiber Spectroscopic Telescope

Hebel, China (2009)

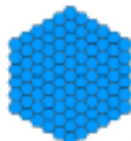

Hobby-Eberly Telescope
Davis Mountains, Texas (1996)



Gran Telescopio Canarias
La Palma, Canary Islands, Spain (2007)



Southern African Large Telescope
Sutherland, South Africa (2005)



Large Binocular Telescope
Mount Graham, Arizona (2005)



Very Large Telescope
Cerro Paranal, Chile (1998-2000)



Magellan Telescopes
Las Campanas, Chile (2000/2002)



Overwhelmingly Large Telescope
(cancelled)

Arecibo radio telescope at the same scale



Keck Telescope
Mauna Kea, Hawaii (1993/1996)



Gemini North
Mauna Kea, Hawaii (1999)



Gemini South
Cerro Pachón, Chile (2000)



Large Synoptic Survey Telescope
El Peñón, Chile (planned 2020)



Giant Magellan Telescope
Las Campanas Observatory, Chile (planned 2020)

Overwhelmingly Large Telescope
(cancelled)

Arecibo radio telescope at the same scale

Subaru Telescope
Mauna Kea, Hawaii (1999)

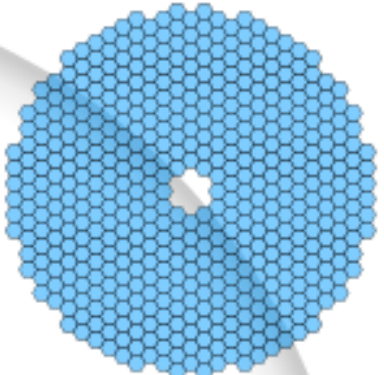

Thirty Meter Telescope
Mauna Kea, Hawaii (planned 2022)

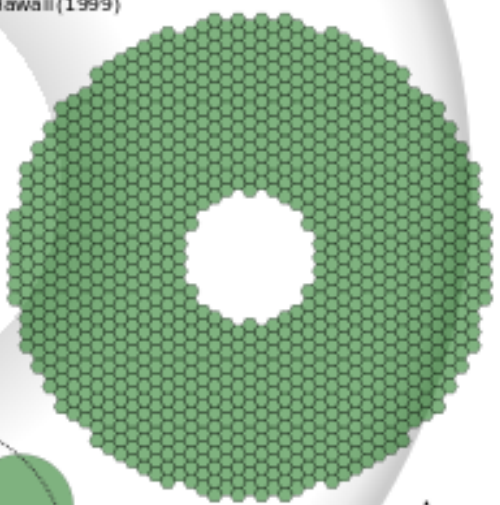

European Extremely Large Telescope
Cerro Armazones, Chile (planned 2022)

Human at the same scale

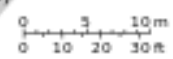

Basketball court at the same scale

observatoře na oběžné dráze

- IRAS
- ISO
- Spitzer Space Telescope (formerly SIRTf, the Space Infrared Telescope Facility)
- HST
- Chandra
- Compton
- cenová rozvaha
- HST x pozemní dal.

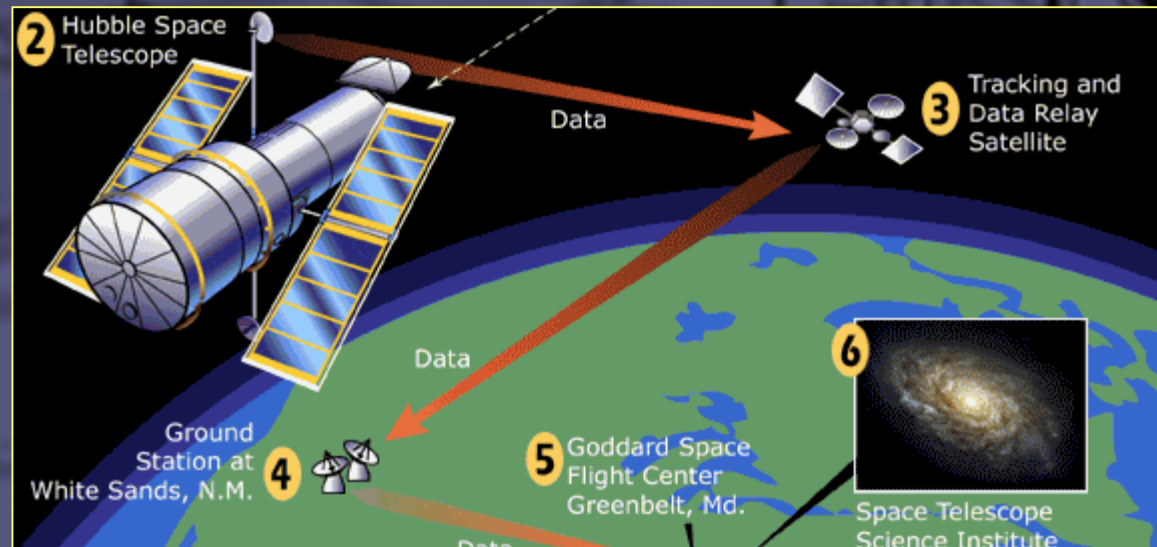

aktivní a adaptivní optické systémy

- **aktivní** – systémy „intelligentních podpěr“ tenkého primárního zrcadla, jehož tvar je neustále korigován
- **adaptivní** – snaha o odstranění vlivu atmosféry na pozorování

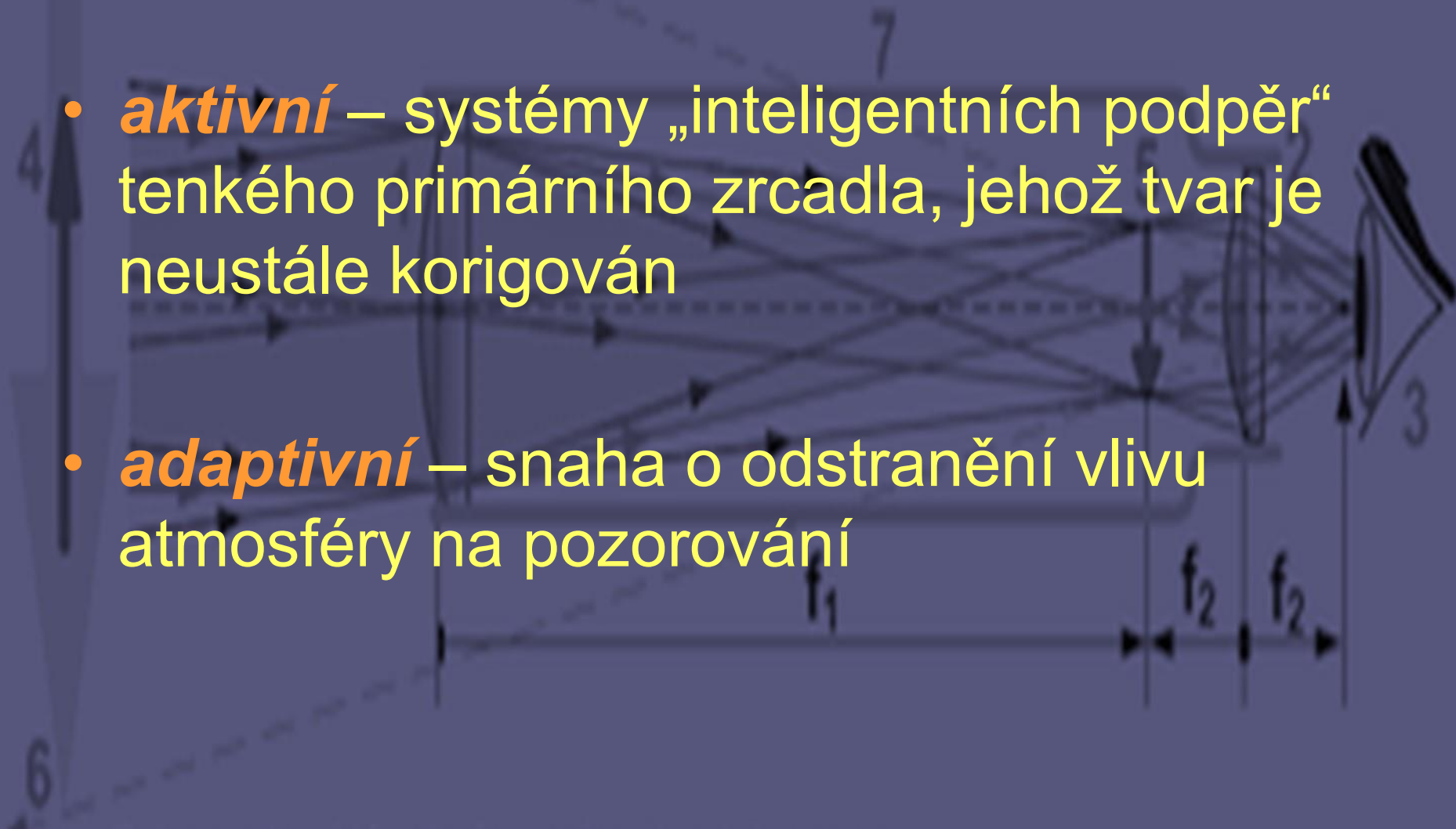

adaptivní optika

- idea z 50. let, poprvé užito na konci 80. let na 3,6 m ESO
- odtajnění vojenských technologií 1991
- AO musí zjistit všechna zkreslení v každém okamžiku a vložit zkreslení „opačná“
- snazší v IR oblasti

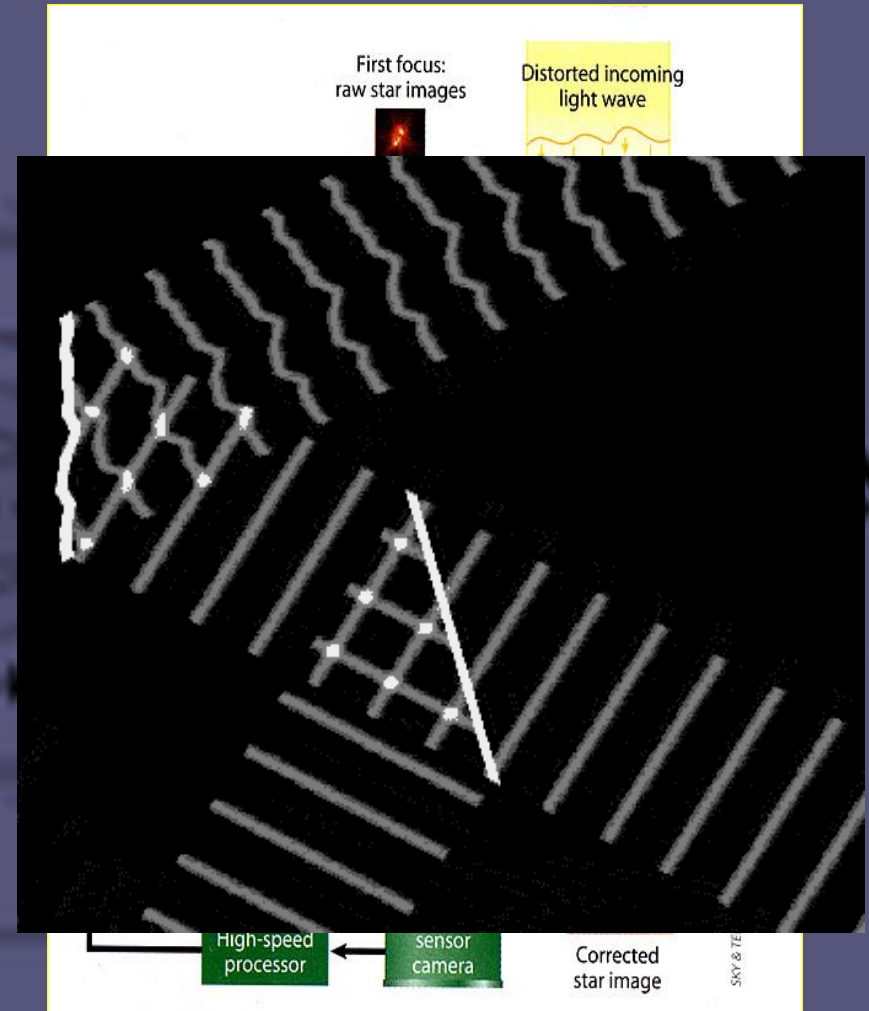

adaptivní optika

- metoda fixace vlnoplochy, jen pro jasné hvězdy v zorném poli
- metoda umělé hvězdy
- systém měření zakřivení vlnoplochy
- metoda atmosférické tomografie
- neuvěřitelné nároky na výpočetní techniku



moderní projekty

- projekty „přehlídkového“ typu

- Visible and Infrared Survey Telescope for Astronomy – VISTA

[https://en.wikipedia.org/wiki/VISTA_\(telescope\)](https://en.wikipedia.org/wiki/VISTA_(telescope))

- Large Sky Area Multi-Object Spectroscopic Telescope – LAMOST

<https://en.wikipedia.org/wiki/LAMOST>

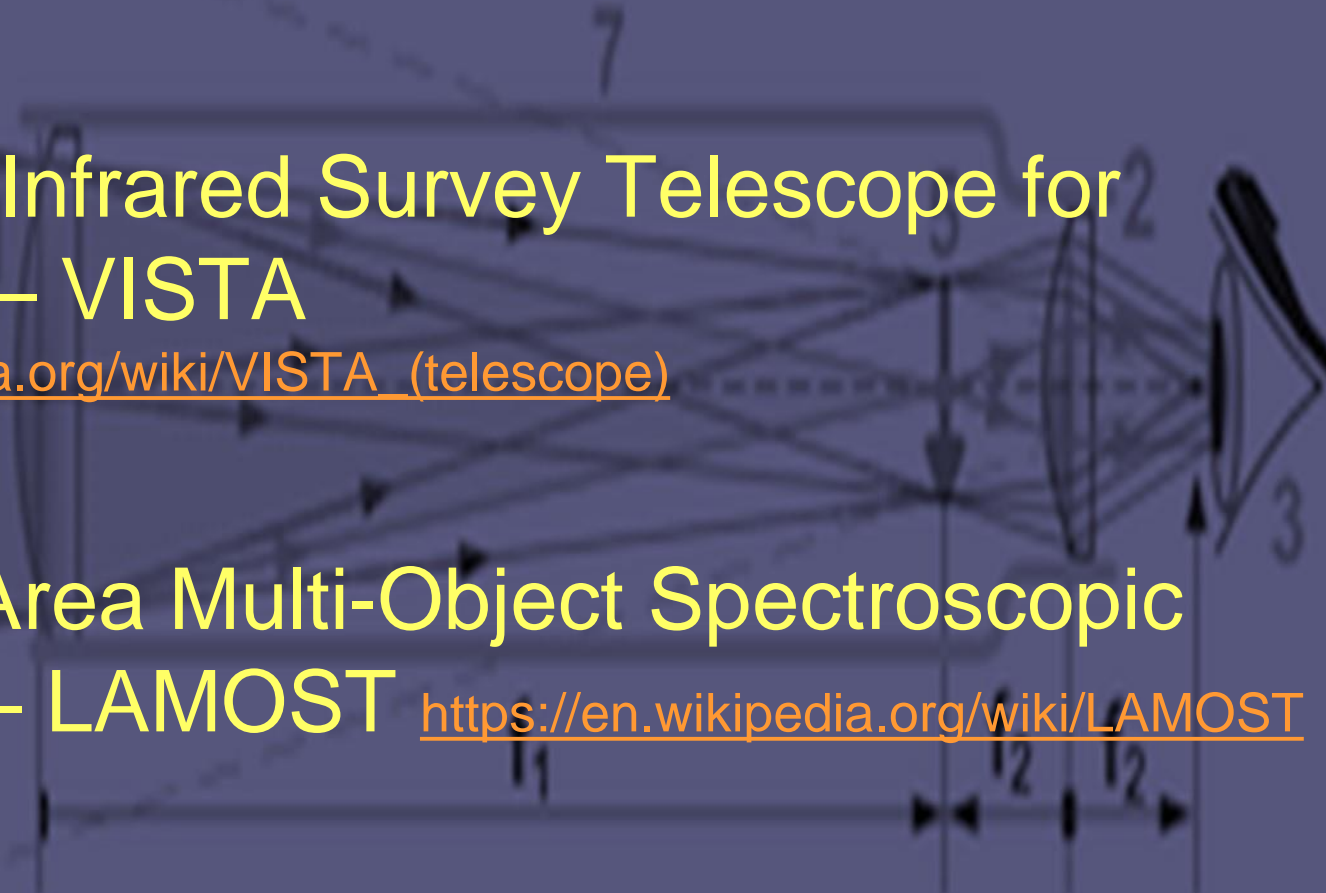

trocha futurologie

gigantické projekty

- European Extremely Large Telescope 39,3 m, snad 2024.^[21]
- Thirty Meter Telescope 30 m, od 2027.^[22]
- Giant Magellan Telescope sedm 8,4 m zrcadel na jedné montáži, rozlišení jako 24,5 m a ekvivalent 21,4 m jednolitého, snad 2029.^[23]

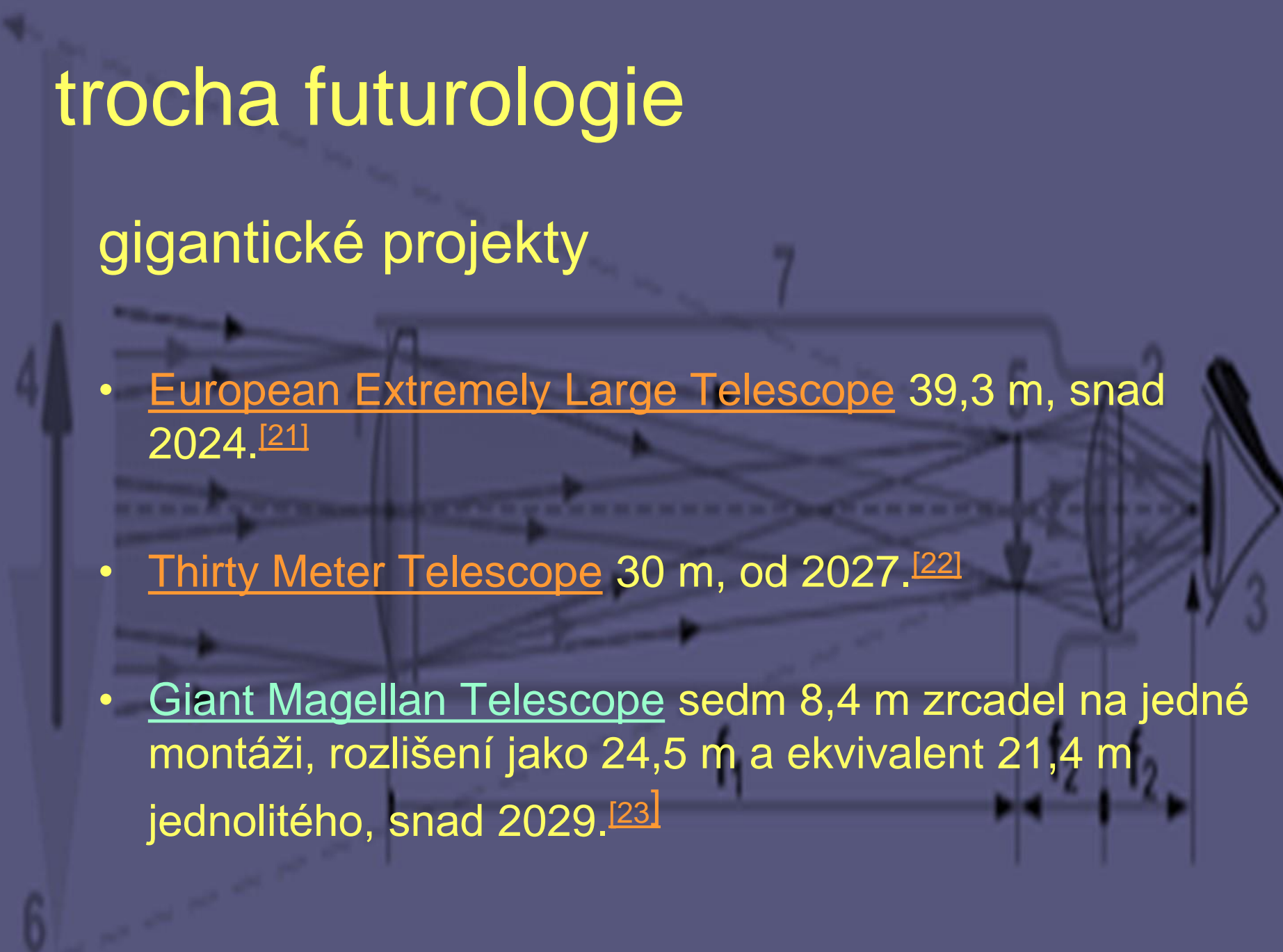

trocha futurologie

gigantické projekty

- [Vera C. Rubin Observatory](#) 8,4 m, plný provoz 2022
- [San Pedro Martir Telescope](#) 6.5 m, snad 2023. ^[25]
- [Magdalena Ridge Observatory Telescope Array](#) optický interferometr, 10 dalekohledů, každý 1,4 m (ekvivalent 4,4 m zrcadlu)



oběžná dráha

- James Webb Space Telescope 6,5 m, snad v říjnu 2021. [\[24\]](#)

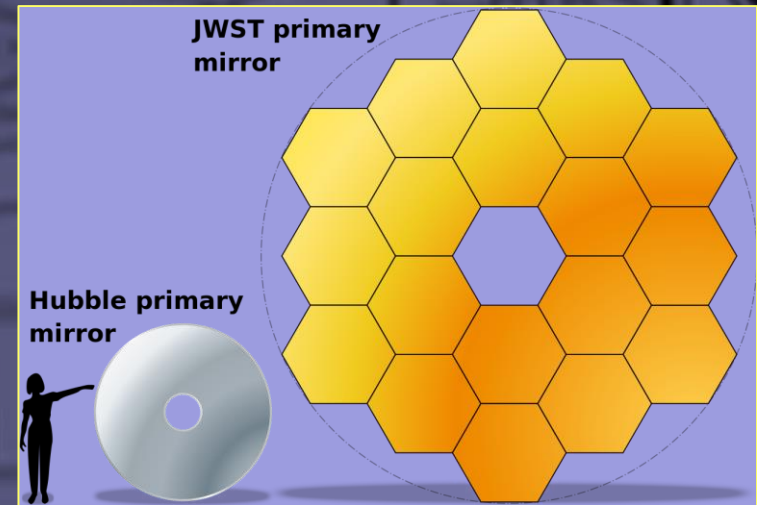
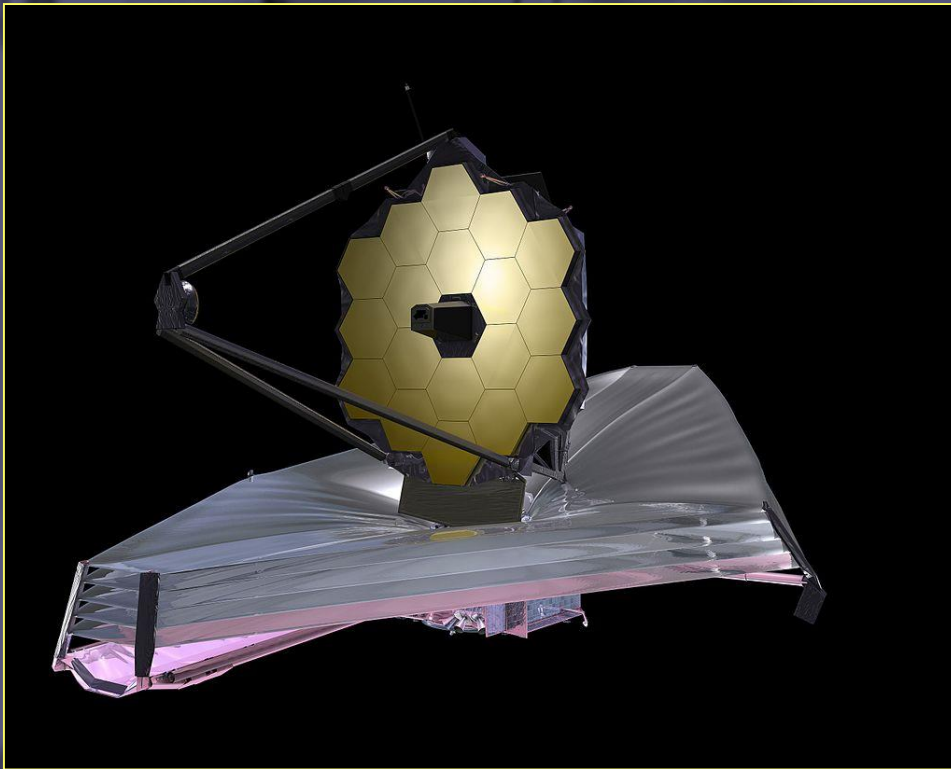

Quo vadis, pozorovací astronomie?

- https://en.wikipedia.org/wiki/List_of_proposed_space_observatories

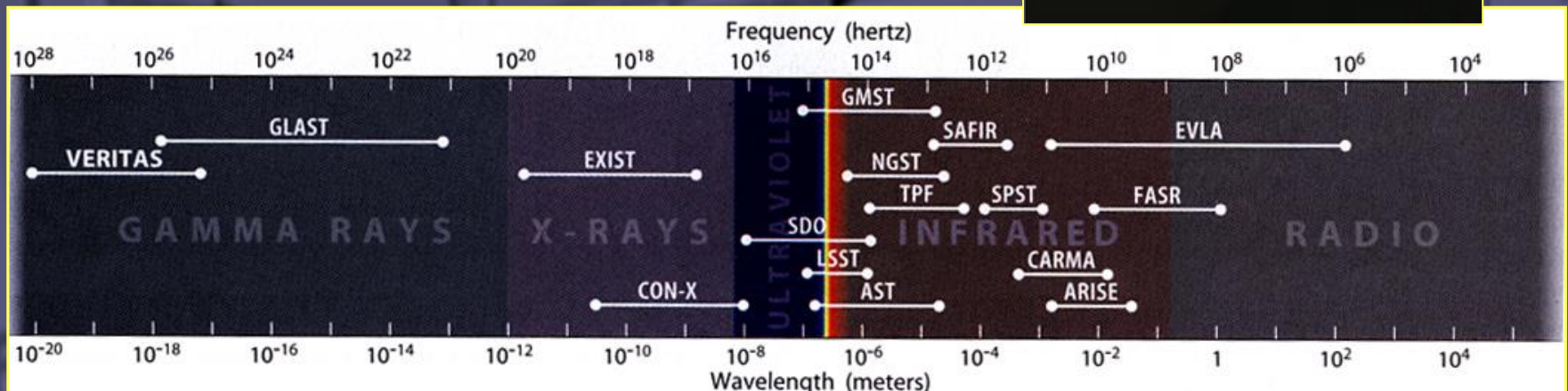
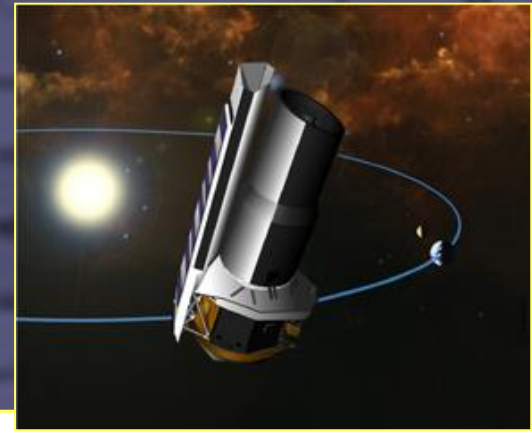

jakpak je dnes u nás doma?

- Perkův 2 m - 65,5 kiloočů
- KLENOT, 1,06 m - 17,5 kiloočů
- 2007 jsme se stali členy ESO !!!
- La Silla 1,54 m "Dánský dalekohled"

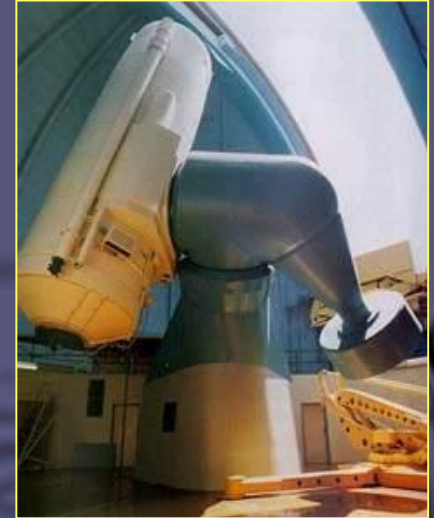

detektory

- 1887 astrofotografie
- 1940 speciální emulze pro spektroskopii (Kodak)
- 1930 použití fotoel. článků
- 1940 fotonásobiče
- 1990 CCD

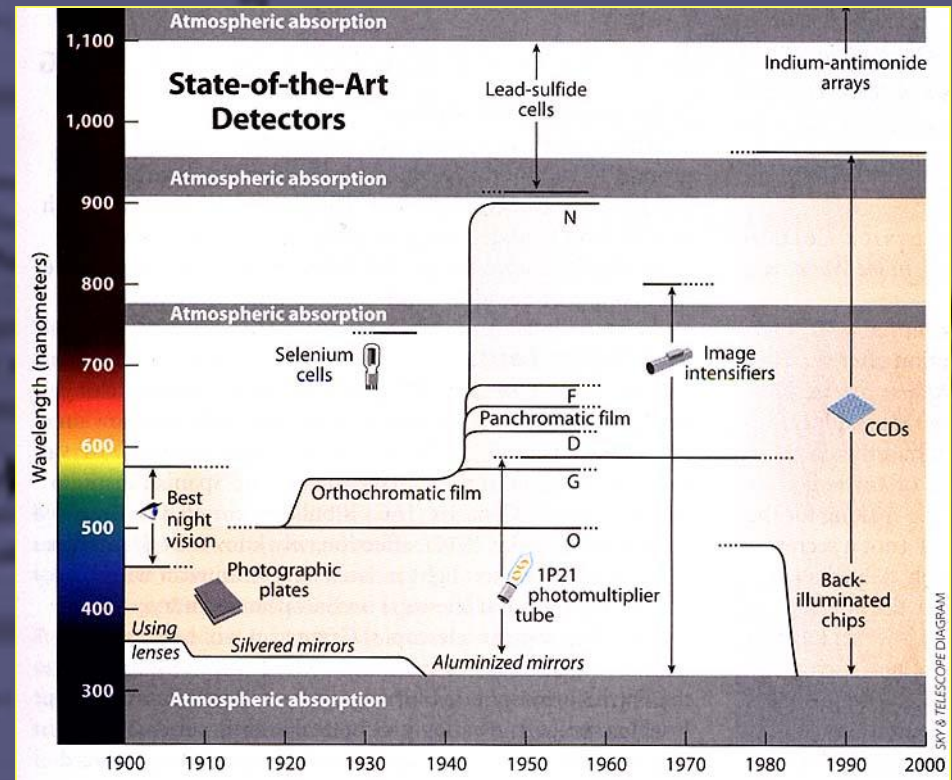

získání pozorovacího času

- neexistuje žádný „záračný návod“
- pozorovací režimy
 - pozorování astronomem přímo na místě
 - vzdálené pozorování
 - pozorování prováděné profesionální obsluhou dalekohledu (plánování systémem „fronta“)
 - robotické dalekohledy (ASAS a jiné)

https://en.wikipedia.org/wiki/Robotic_telescope

<http://www.astro.physik.uni-goettingen.de/~hessman/MONET/links.html>



praktická astronomie „pro radost“ I

(včetně kritického komentáře)

- technika a praxe Hollanův rádce , texty Pavla Cagaše Jak kupovat dalekohled a Jak používat dalekohled
- pozorování - seriál V ohnisku
 - slunečních skvrn
 - zatmění Slunce
 - Měsíce
 - zákrytů hvězd
 - planetek
 - planet



... game is over ...

