

The background features a dark blue gradient with a field of small white stars. Overlaid on this are several white line-art diagrams of celestial orbits. These include concentric circles, elliptical paths, and arcs with arrows indicating the direction of motion. A prominent circular scale with numerical markings from 40 to 260 in increments of 10 is visible on the left side. The overall aesthetic is scientific and technical.

POHYB TĚLES VE SLUNEČNÍ SOUSTAVĚ

OPOZICE, KONJUNKCE, ELONGACE,
KEPLEROVY ZÁKONY POHYBU PLANET,
DRÁHOVÉ ELEMENTY, KEPLEROVA ROVNICE,
RETROGRÁDNÍ POHYB VNĚJŠÍCH PLANET,
KOMETY

OPOZICE, KONJUNKCE, ELONGACE

- Země obíhá kolem Slunce v rovině ekliptiky, jež svírá s rovinou světového rovníku úhel $\varepsilon = 23^{\circ}27'$
- pohyb Slunce během roku po hvězdné obloze se děje právě po ekliptice, pohyb planet po hvězdné obloze v průběhu roku je mnohem složitější
- rozlišujeme některé význačné polohy:
 - 1) *konjunkce*
 - 2) *opozice*
 - 3) *největší elongace*

OPOZICE, KONJUNKCE, ELONGACE

- **Konjunkce** dvou těles nastává při shodné rektascenzi dvou objektů, u tzv. vnitřních planet (Venuše, Merkur) rozlišujeme k. dolní (planeta je mezi Zemí a Sluncem) a horní k. v opačném případě
- **Opozice** dvou těles nastává v okamžiku, kdy se liší rektascenze dvou těles o 180° , je to nejpříznivější poloha k pozorování; těleso kulminuje o půlnoci, je-li v opozici se Sluncem, nemůže nastat pro vnitřní planety a Slunce
- **Maximální elongace** je největší úhlová vzdálenost od Slunce, které dosáhne některá z vnitřních planet
- někdy se lze setkat i s pojmem **kvadratura**, pro vnější planetu nastává, je-li její elongace 90°

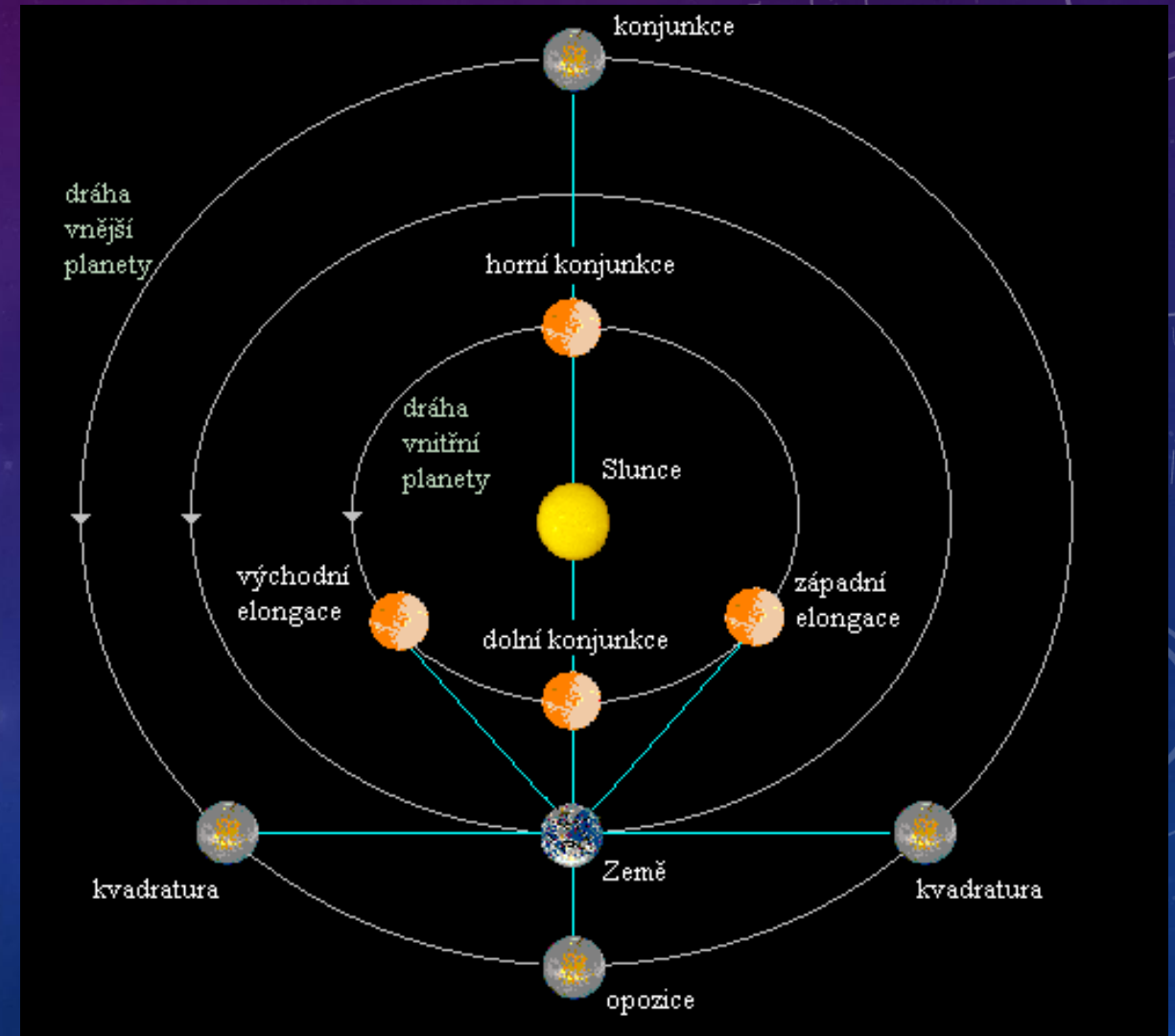

RETROGRÁDNÍ POHYB VNĚJŠÍCH PLANET

- Pro pozorovatele na pohybující se Zemi tvoří dráhy planet na hvězdné obloze v průběhu roku jakési „smyčky“
- Je to výsledek skládání pohybů pozorovatele (Země) a planety

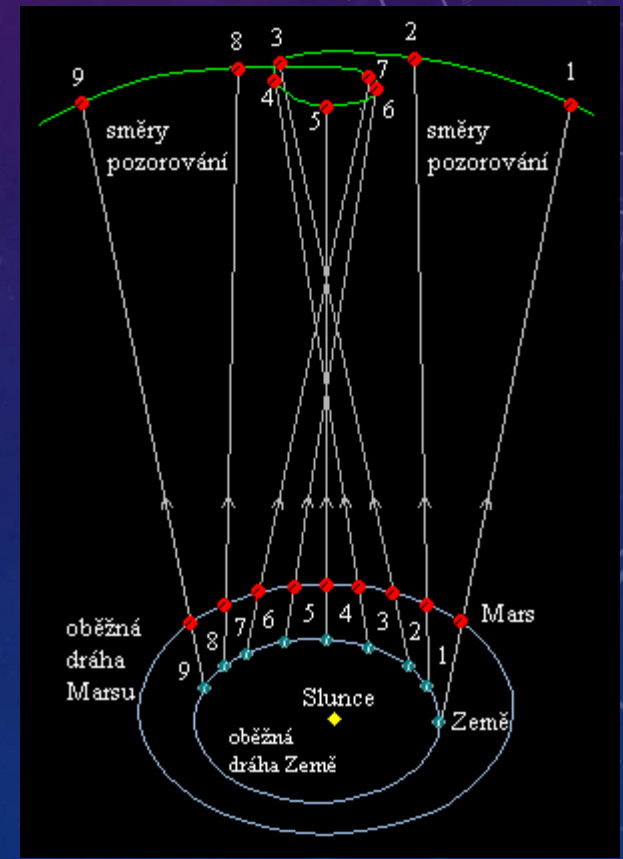

POHYB PLANET

- **siderická perioda** - 1 oběh planety kolem Slunce vzhledem ke hvězdám
- **synodická perioda** - čas mezi dvěma po sobě následujícími konjunkcemi planety se Sluncem. Pro vnitřní planety platí $T_{syn} = T_{sid} / (1 - T_{sid})$, pro vnější $T_{syn} = T_{sid} / (T_{sid} - 1)$
- <https://www.youtube.com/watch?v=libKVRa01L8>
- **Opavský městský model Sluneční soustavy**
- <https://solarsystemopava.webnode.cz/>

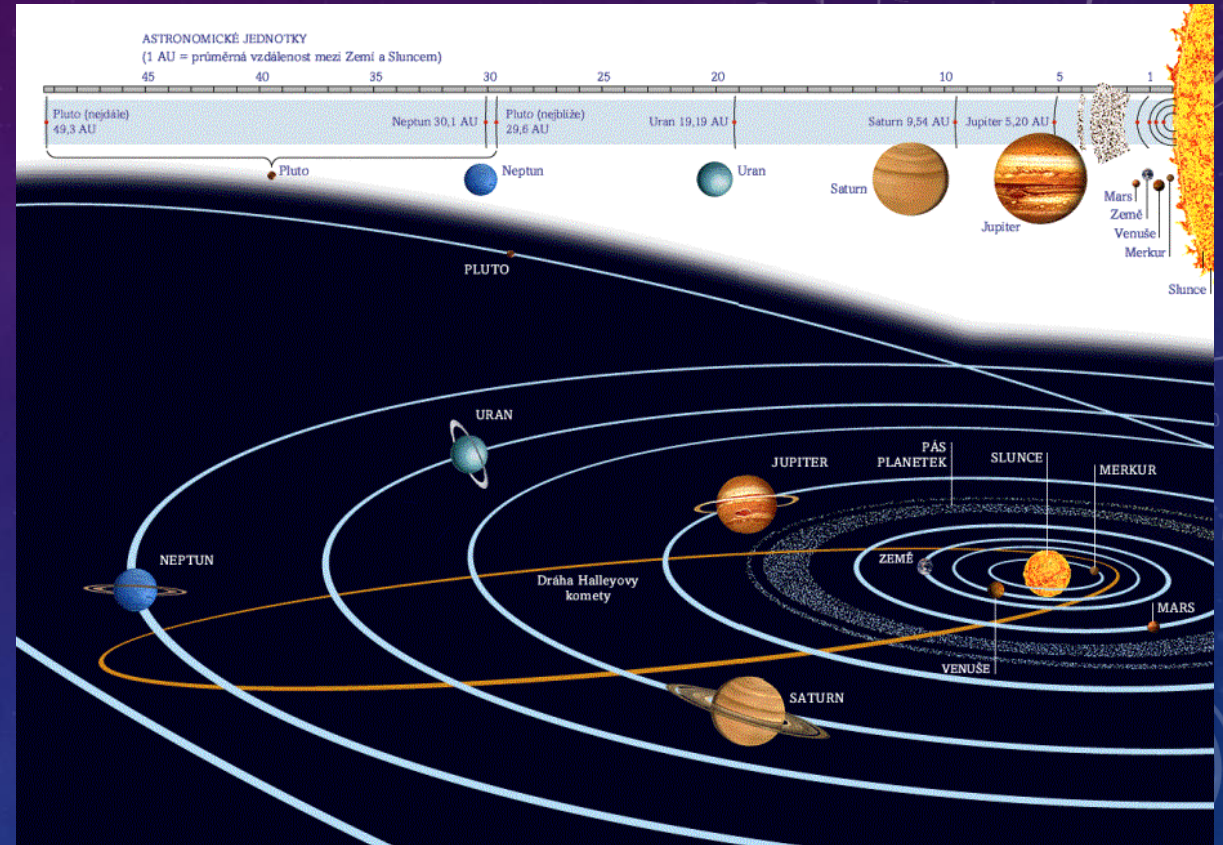

KEPLEROVY ZÁKONY POHYBU PLANET

- podkladem pro Keplerovu formulaci tří zákonů, které popisují pohyb těles ve sluneční soustavě byla velmi přesná vizuální pozorování, která v 16. století učinil Tycho Brahe
1. ***Planety se pohybují po elipsách od kruhů málo odlišných, v jejichž společném ohnisku je Slunce.***
 2. ***Plochy opsané průvodičem planety za jednotku času jsou shodné.***
 3. ***Dvojmoci dob oběhů mají se k sobě jako trojmoci velkých poloos.***

1. KEPLERŮV ZÁKON

1. dráhami jsou elipsy s malou excentricitou, $e = c/a$ numerická excentricita

- e Země = 0,0167
- e Merkura = 0,206

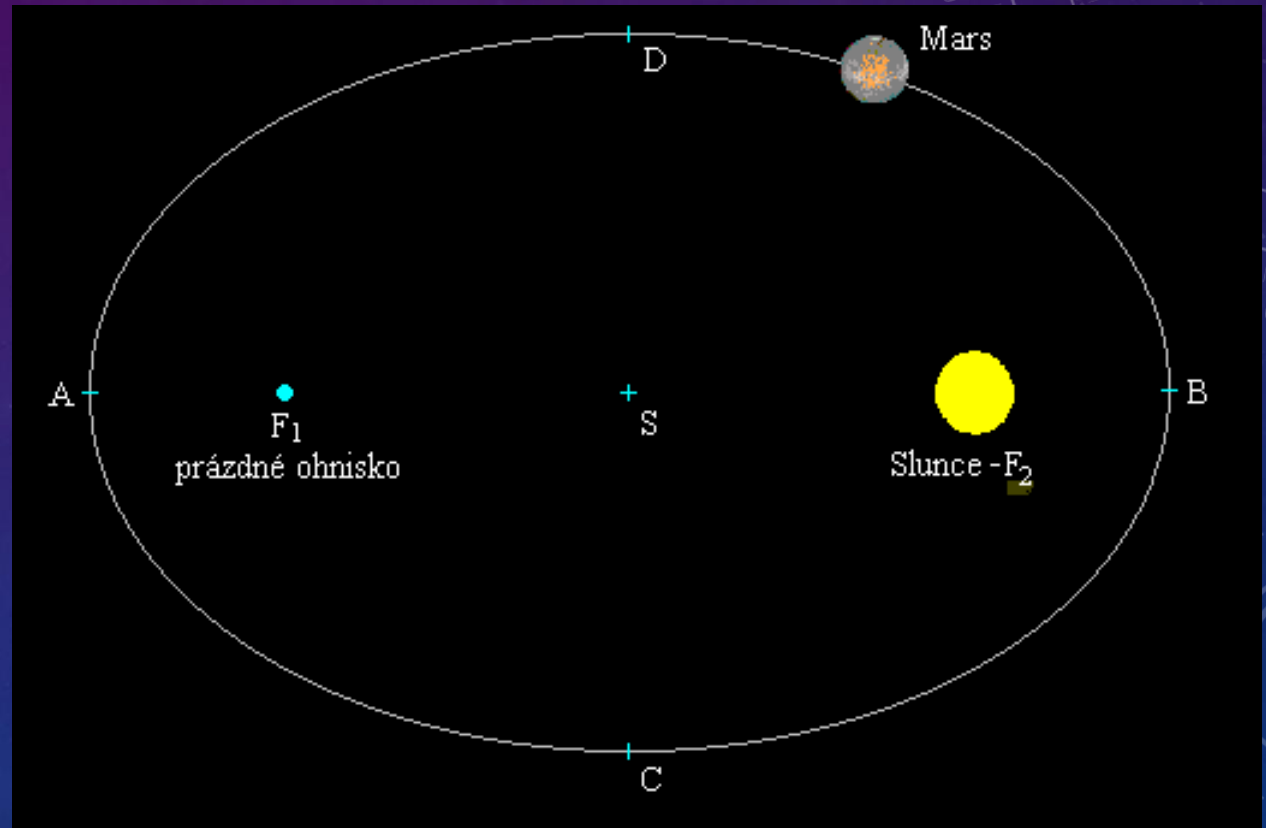

2. KEPLERŮV ZÁKON

- spojnice perihelu a afelu - tzv. *přímka apsid*
- Plocha S1 = plocha S2 za shodný časový interval

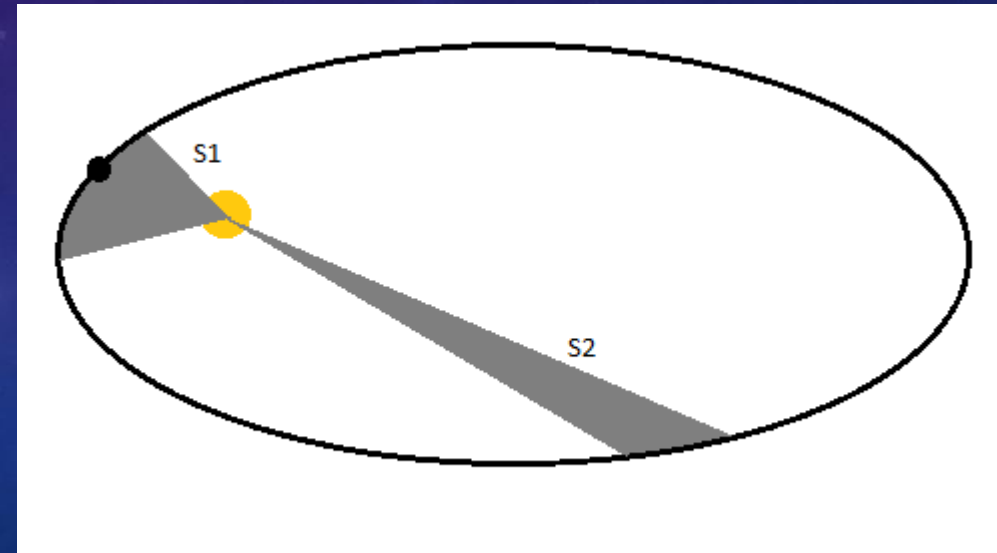

3. KEPLERŮV ZÁKON

- platí $T_1^2/T_2^2 = a_1^3/a_2^3$
- přesné znění formuloval až Newton, který empirické zákony Keplera zdůvodnil fyzikálně:
- $T_1^2/T_2^2 = (a_1^3/a_2^3) \cdot (M + m_1)/(M + m_2)$,
- kde M je hmotnost Slunce, m_1 a m_2 jsou hmotnosti planet
- Pro $m_{1,2} \ll M$ je možno druhý člen na pravé straně rovnice zanedbat.
- <https://www.youtube.com/watch?v=oE5sUAdxIxM>

DRÁHOVÉ ELEMENTY

a ... velká poloosa
 e ... excentricita
velikost a tvar dráhy

i ... sklon dráhy
 Ω ... délka výstupného uzlu
orientace roviny dráhy v prostoru

ω ... argument perihelu
(délka perihelu: $\omega' = \Omega + \omega$)
orientace dráhy v její rovině

T ... okamžik průchodu perihéliem
poloha tělesa na dráze

uzlová přímka: spojnice výstupného a sestupného uzlu
přímka apsid: spojnice perihélia a afélia

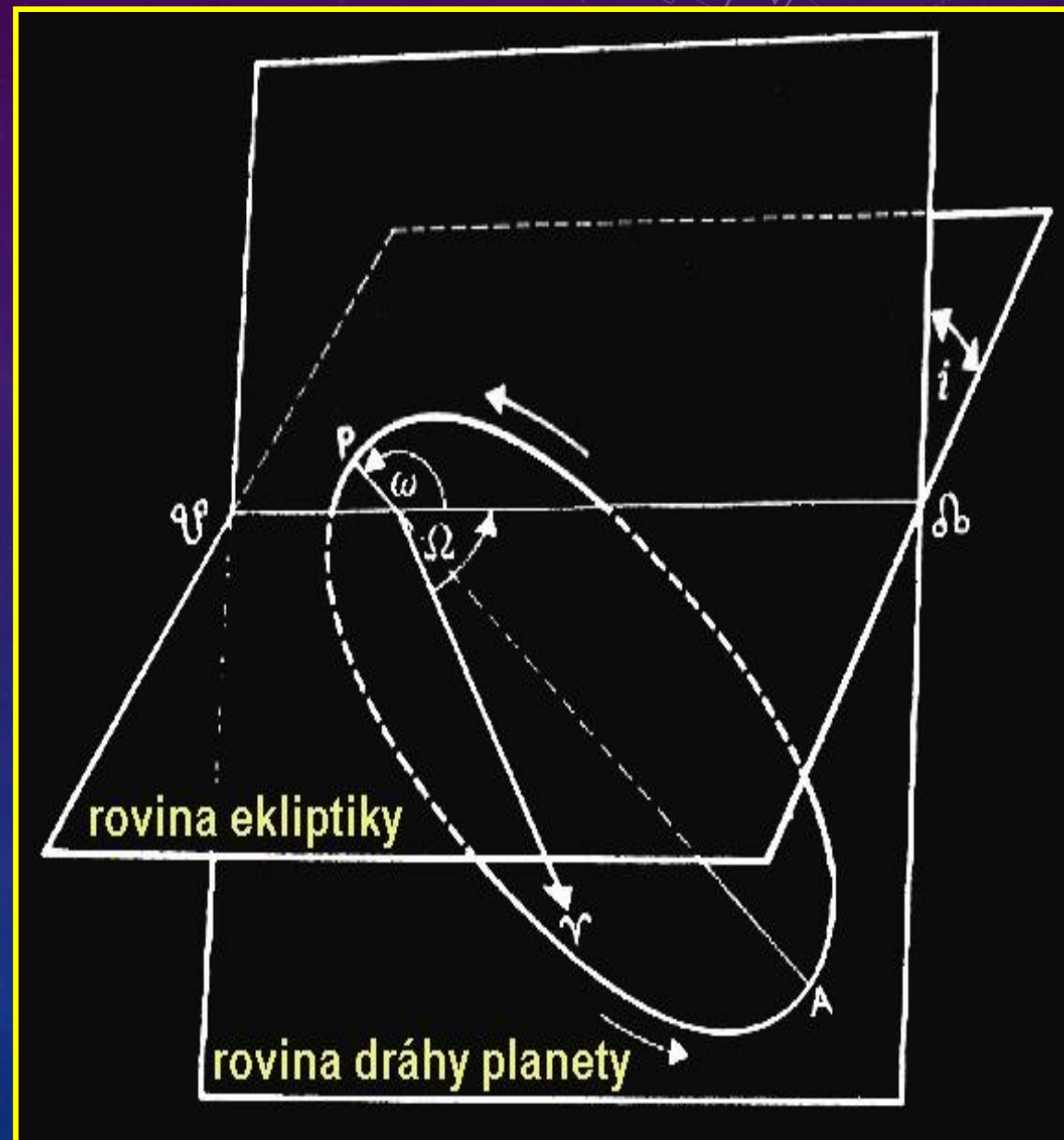

KEPLEROVA ROVNICE

The three-body problem has some interesting special solutions. It can be shown that in certain points the third body can remain at rest with respect to the primaries. There are five such points, known as the *Lagrangian points* L_1, \dots, L_5 (Fig. 6.8). Three of them are on the straight line determined by the primaries. These points are unstable: if a body in any of these points is disturbed, it will escape. The two other points, on the other hand, are stable. These points together with the primaries form equilateral triangles. For example, some *asteroids* have been found around the Lagrangian points L_4 and L_5 of Jupiter and Mars. The first of them were named after heroes of the Trojan war, and so they are called *Trojan asteroids*. They move around the Lagrangian points and can actually travel quite far from them, but they cannot escape. Fig. 7.56 shows two distinct condensations around the Lagrangian points of Jupiter.

6.7 Orbit Determination

Celestial mechanics has two very practical tasks: to determine orbital elements from observations and to predict positions of celestial bodies with known elements. Planetary orbits are already known very accurately, but new comets and minor planets are found frequently, requiring orbit determination.

The first practical methods for orbit determination were developed by *Johann Karl Friedrich Gauss* (1777–1855) at the beginning of the 19th century. By that time the first minor planets had been discovered, and thanks to Gauss's orbit determinations, they could be found and observed at any time.

At least three observations are needed for computing the orbital elements. The directions are usually measured from pictures taken a few nights apart. Using these directions, it is possible to find the corresponding absolute positions (the rectangular components of the radius vector). To be able to do this, we need some additional constraints on the orbit; we must assume that the object moves along a conic section lying in a plane that passes through the Sun. When the three radius vectors are known, the ellipse (or some other conic section) going through these three points can be determined. In practice, more observations are used. The elements determined are more accurate if there are more observations and if they cover the orbit more completely.

Although the calculations for orbit determination are not too involved mathematically, they are relatively long and laborious. Several methods can be found in textbooks of celestial mechanics.

6.8 Position in the Orbit

Although we already know everything about the geometry of the orbit, we still cannot find the planet at a given time, since we do not know the radius vector \mathbf{r} as a function of time. The variable in the equation of the orbit is an angle, the true anomaly f , measured from the perihelion. From Kepler's second law it follows that f cannot increase at a constant rate with time. Therefore we need some preparations before we can find the radius vector at a given instant.

The radius vector can be expressed as

$$\mathbf{r} = a(\cos E - e)\hat{\mathbf{i}} + b \sin E \hat{\mathbf{j}}, \quad (6.34)$$

where $\hat{\mathbf{i}}$ and $\hat{\mathbf{j}}$ are unit vectors parallel with the major and minor axes, respectively. The angle E is the *eccentric anomaly*; its slightly eccentric definition is shown in Fig. 6.9. Many formulas of elliptical motion become very simple if either time or true anomaly is replaced

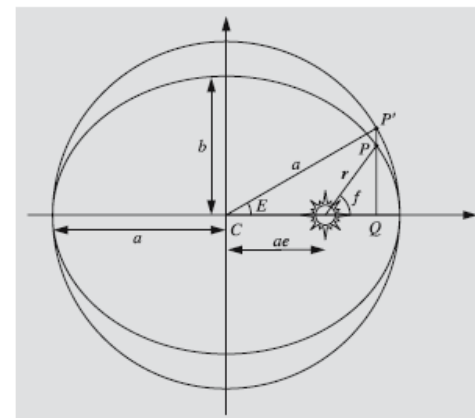

Fig. 6.9. Definition of the eccentric anomaly E . The planet is at P , and \mathbf{r} is its radius vector

KEPLEROVA ROVNICE

by the eccentric anomaly. As an example, we take the square of (6.34) to find the distance from the Sun:

$$\begin{aligned} r^2 &= \mathbf{r} \cdot \mathbf{r} \\ &= a^2(\cos E - e)^2 + b^2 \sin^2 E \\ &= a^2[(\cos E - e)^2 + (1 - e^2)(1 - \cos^2 E)] \\ &= a^2[1 - 2e \cos E + e^2 \cos^2 E], \end{aligned}$$

whence

$$r = a(1 - e \cos E). \quad (6.35)$$

Our next problem is to find how to calculate E for a given moment of time. According to Kepler's second law, the surface velocity is constant. Thus the area of the shaded sector in Fig. 6.10 is

$$A = \pi ab \frac{t - \tau}{P}, \quad (6.36)$$

where $t - \tau$ is the time elapsed since the perihelion, and P is the orbital period. But the area of a part of an ellipse is obtained by reducing the area of the corresponding part of the circumscribed circle by the axial ratio b/a . (As the mathematicians say, an ellipse is an

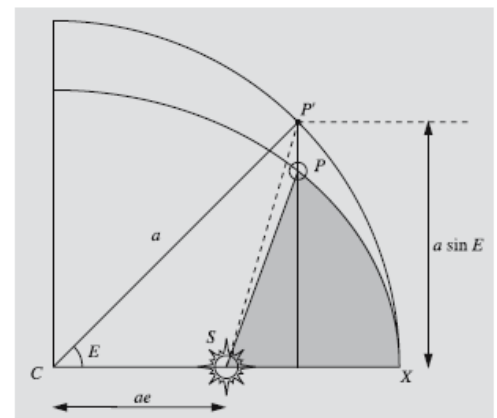

Fig. 6.10. The area of the shaded sector equals b/a times the area $SP'X$. S is the Sun, P is the planet, X is the perihelion

affine transformation of a circle.) Hence the area of SPX is

$$\begin{aligned} A &= \frac{b}{a} (\text{area of } SP'X) \\ &= \frac{b}{a} (\text{area of the sector } CP'X \\ &\quad - \text{area of the triangle } CP'S) \\ &= \frac{b}{a} \left(\frac{1}{2} a \cdot a E - \frac{1}{2} a e \cdot a \sin E \right) \\ &= \frac{1}{2} ab(E - e \sin E). \end{aligned}$$

By equating these two expressions for the area A , we get the famous *Kepler's equation*,

$$E - e \sin E = M, \quad (6.37)$$

where

$$M = \frac{2\pi}{P}(t - \tau) \quad (6.38)$$

is the *mean anomaly* of the planet at time t . The mean anomaly increases at a constant rate with time. It indicates where the planet would be if it moved in a circular orbit of radius a . For circular orbits all three anomalies f , E , and M are always equal.

If we know the period and the time elapsed after the perihelion, we can use (6.38) to find the mean anomaly. Next we must solve for the eccentric anomaly from Kepler's equation (6.37). Finally the radius vector is given by (6.35). Since the components of r expressed in terms of the true anomaly are $r \cos f$ and $r \sin f$, we find

$$\begin{aligned} \cos f &= \frac{a(\cos E - e)}{r} = \frac{\cos E - e}{1 - e \cos E}, \\ \sin f &= \frac{b \sin E}{r} = \sqrt{1 - e^2} \frac{\sin E}{1 - e \cos E}. \end{aligned} \quad (6.39)$$

These determine the true anomaly, should it be of interest.

Now we know the position in the orbital plane. This must usually be transformed to some other previously selected reference frame. For example, we may want to know the ecliptic longitude and latitude, which can later be used to find the right ascension and declination. These transformations belong to the realm of spherical astronomy and are briefly discussed in Examples 6.5–6.7.

6.9 Escape Velocity

If an object moves fast enough, it can escape from the gravitational field of the central body (to be precise: the field extends to infinity, so the object never really escapes, but is able to recede without any limit). If the escaping object has the minimum velocity allowing escape, it will have lost all its velocity at infinity (Fig. 6.11). There its kinetic energy is zero, since $v = 0$, and the potential energy is also zero, since the distance r is infinite. At infinite distance the total energy as well as the energy integral h are zero. The law of conservation of energy gives, then:

$$\frac{1}{2}v^2 - \frac{\mu}{R} = 0, \quad (6.40) \quad P = \frac{2\pi R}{v_c}.$$

where R is the initial distance at which the object is moving with velocity v . From this we can solve the *escape velocity*:

$$v_e = \sqrt{\frac{2\mu}{R}} = \sqrt{\frac{2G(m_1 + m_2)}{R}}. \quad (6.41)$$

For example on the surface of the Earth, v_e is about 11 km/s (if $m_2 \ll m_\oplus$).

The escape velocity can also be expressed using the orbital velocity of a circular orbit. The orbital period P as a function of the radius R of the orbit and the orbital velocity v_c is

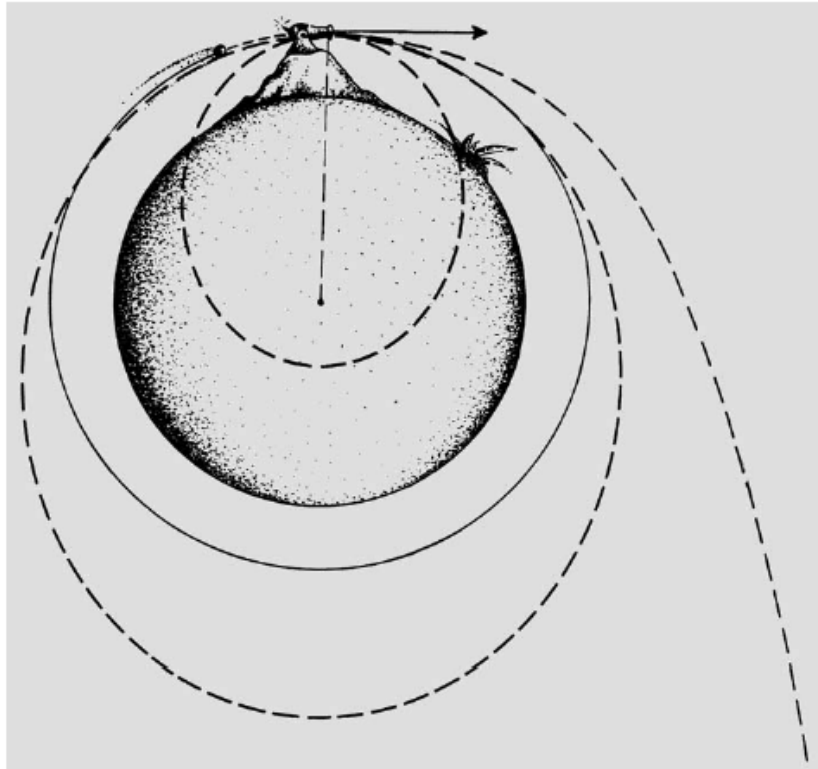

Fig. 6.11. A projectile is shot horizontally from a mountain on an atmosphereless planet. If the initial velocity is small, the orbit is an ellipse whose pericentre is inside the planet, and the projectile will hit the surface of the planet. When the velocity is increased, the pericentre moves outside the planet. When the initial velocity is v_c , the orbit is circular. If the velocity is increased further, the eccentricity of the orbit grows again and the pericentre is at the height of the cannon. The apocentre moves further away until the orbit becomes parabolic when the initial velocity is v_e . With even higher velocities, the orbit becomes hyperbolic.

ÚNIKOVÁ RYCHLOST

6. Celestial Mechanics

124

Substitution into Kepler's third law yields

$$\frac{4\pi^2 R^2}{v_c^2} = \frac{4\pi^2 R^3}{G(m_1 + m_2)}.$$

From this we can solve the velocity v_c in a circular orbit of radius R :

$$v_c = \sqrt{\frac{G(m_1 + m_2)}{R}}. \quad (6.42)$$

Comparing this with the expression (6.41) of the escape velocity, we see that

$$v_e = \sqrt{2}v_c. \quad (6.43)$$

VIRIÁLOVÝ TEORÉM

6.10 Virial Theorem

If a system consists of more than two objects, the equations of motion cannot in general be solved analytically (Fig. 6.12). Given some initial values, the orbits can, of course, be found by numerical integration, but this does not tell us anything about the general properties of all possible orbits. The only integration constants available for an arbitrary system are the total momentum, angular momentum and energy. In addition to these, it is possible to derive certain statistical results, like the virial theorem. It concerns time averages only, but does not say anything about the actual state of the system at some specified moment.

Suppose we have a system of n point masses m_i with radius vectors \mathbf{r}_i and velocities $\dot{\mathbf{r}}_i$. We define a quantity A (the “virial” of the system) as follows:

$$A = \sum_{i=1}^n m_i \dot{\mathbf{r}}_i \cdot \mathbf{r}_i. \quad (6.44)$$

The time derivative of this is

$$\dot{A} = \sum_{i=1}^n (m_i \dot{\mathbf{r}}_i \cdot \dot{\mathbf{r}}_i + m_i \ddot{\mathbf{r}}_i \cdot \mathbf{r}_i). \quad (6.45)$$

The first term equals twice the kinetic energy of the i th particle, and the second term contains a factor $m_i \ddot{\mathbf{r}}_i$ which, according to Newton’s laws, equals the force applied to the i th particle. Thus we have

$$\dot{A} = 2T + \sum_{i=1}^n \mathbf{F}_i \cdot \mathbf{r}_i, \quad (6.46)$$

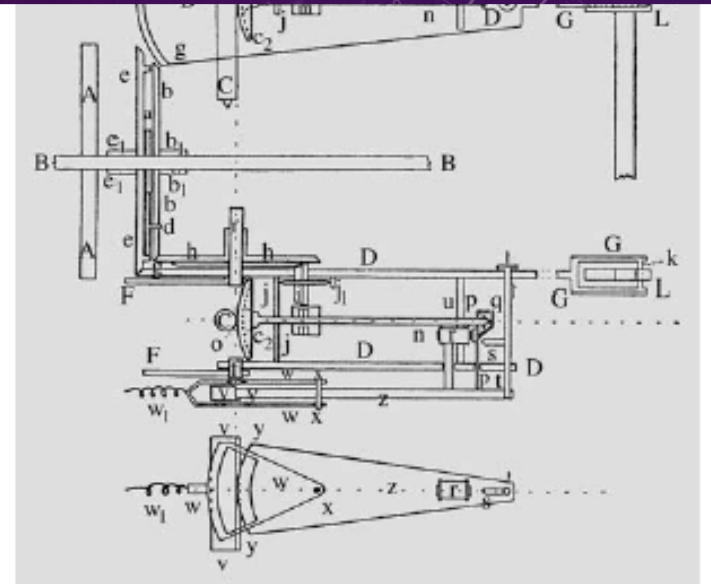

Fig. 6.12. When a system consists of more than two bodies, the equations of motion cannot be solved analytically. In the solar system the mutual disturbances of the planets are usually small and can be taken into account as small perturbations in the orbital elements. K.F. Sundman designed a machine to carry out the tedious integration of the perturbation equations. This machine, called the perturbograph, is one of the earliest analogue computers; unfortunately it was never built. Shown is a design for one component that evaluates a certain integral occurring in the equations. (The picture appeared in K.F. Sundman’s paper in *Festschrift tillegnad Anders Donner* in 1915.)

where T is the total kinetic energy of the system. If $\langle x \rangle$ denotes the time average of x in the time interval $[0, \tau]$, we have

$$\langle \dot{A} \rangle = \frac{1}{\tau} \int_0^{\tau} \dot{A} dt = \langle 2T \rangle + \left\langle \sum_{i=1}^n \mathbf{F}_i \cdot \mathbf{r}_i \right\rangle. \quad (6.47)$$

VIRIÁLOVÝ TEORÉM

If the system remains bounded, i. e. none of the particles escapes, all \mathbf{r}_i 's as well as all velocities will remain bounded. In such a case, A does not grow without limit, and the integral of the previous equation remains finite. When the time interval becomes longer ($\tau \rightarrow \infty$), $\langle \dot{A} \rangle$ approaches zero, and we get

$$\langle 2T \rangle + \left\langle \sum_{i=1}^n \mathbf{F}_i \cdot \mathbf{r}_i \right\rangle = 0. \quad (6.48)$$

This is the general form of the virial theorem. If the forces are due to mutual gravitation only, they have the expressions

$$\mathbf{F}_i = -Gm_i \sum_{j=1, j \neq i}^n m_j \frac{\mathbf{r}_i - \mathbf{r}_j}{r_{ij}^3}, \quad (6.49)$$

where $r_{ij} = |\mathbf{r}_i - \mathbf{r}_j|$. The latter term in the virial theorem is now

$$\begin{aligned} \sum_{i=1}^n \mathbf{F}_i \cdot \mathbf{r}_i &= -G \sum_{i=1}^n \sum_{j=1, j \neq i}^n m_i m_j \frac{\mathbf{r}_i - \mathbf{r}_j}{r_{ij}^3} \cdot \mathbf{r}_i \\ &= -G \sum_{i=1}^n \sum_{j=i+1}^n m_i m_j \frac{\mathbf{r}_i - \mathbf{r}_j}{r_{ij}^3} \cdot (\mathbf{r}_i - \mathbf{r}_j), \end{aligned}$$

where the latter form is obtained by rearranging the double sum, combining the terms

$$m_i m_j \frac{\mathbf{r}_i - \mathbf{r}_j}{r_{ij}^3} \cdot \mathbf{r}_i$$

and

$$m_j m_i \frac{\mathbf{r}_j - \mathbf{r}_i}{r_{ji}^3} \cdot \mathbf{r}_j = m_i m_j \frac{\mathbf{r}_i - \mathbf{r}_j}{r_{ij}^3} \cdot (-\mathbf{r}_j).$$

Since $(\mathbf{r}_i - \mathbf{r}_j) \cdot (\mathbf{r}_i - \mathbf{r}_j) = r_{ij}^2$ the sum reduces to

$$-G \sum_{i=1}^n \sum_{j=i+1}^n \frac{m_i m_j}{r_{ij}} = U,$$

where U is the potential energy of the system. Thus, the virial theorem becomes simply

$$\langle T \rangle = -\frac{1}{2} \langle U \rangle. \quad (6.50)$$

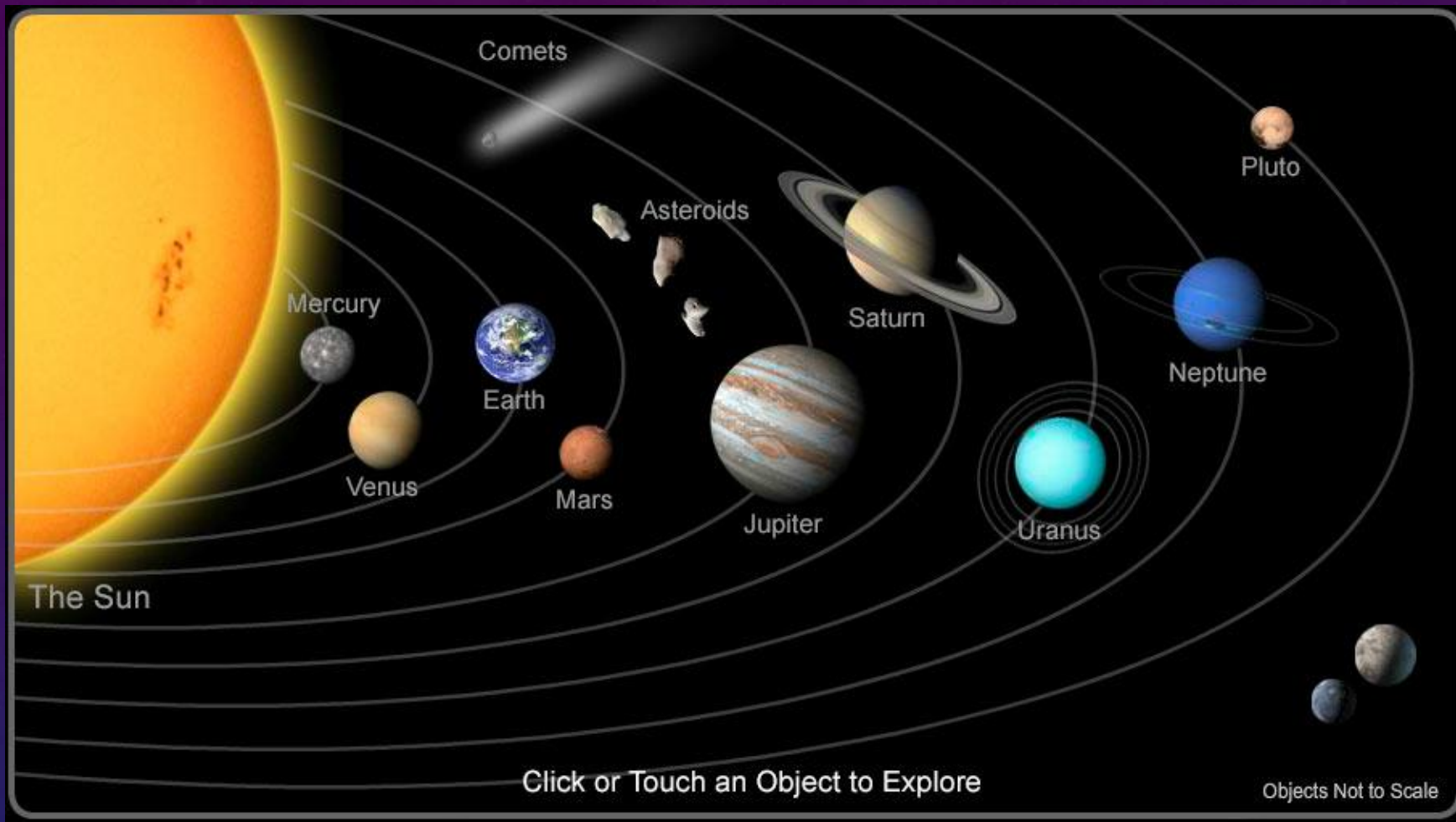

...:: NAKONEC KONEC ::...